



Academia

FURNITURE INDUSTRIES

School Furniture Catalog





Create An **Ideal Learning Environment**

With Flexible, Collaborative Classroom Furniture.

Promise & **Philosophy**

Discover Academia Furniture's unique style for the 21st century classroom - **fun, vibrant, colorful, comfortable & versatile.**

Our Promise: To exceed your expectations in innovative classroom furniture by personally and helpfully servicing your every need promptly in a true relationship-based association.

Our philosophy: To provide what we promise, when we promise, at a competitive price.

Environmentally **Conscious**



Earning 100% compliance with the most stringent standards by recognized independent testing agencies, Academia goes further by reducing our environmental footprint and constantly testing to ensure that all products are classroom-safe and kid-friendly (**MAS Certified Green and LEED compliant**).

We Design **Innovative Products**

Making you look good makes us proud. Design, safety, utility, comfort, stability and durability are just the start. Colors, shapes, sizes, finishes, gliding or immobile - the choices abound.

From prestigious public schools to new charter schools, students, teachers and administration are delighted with Academia's quality and versatility. **Let's see how good we can make you look.**

15-Year **Warranty**



Academia Furniture Industries offers the original user a limited fifteen-year warranty against all manufacturing defects in **material and workmanship** from date of purchase.



Scan to
Learn More About Us

School Environments 4-19

School Seating

Size & Ordering Information

20-31

30-31

Classroom Table

Size & Ordering Information

88-111

108-111

Soft Seating

Size & Ordering Information

32-43

42-43

Teacher Desk

Size & Ordering Information

112-123

122-123

Student Desk

Size & Ordering Information

44-71

70-71

Media Center

Size & Ordering Information

124-135

134-135

Combo Desk

Size & Ordering Information

72-87

84-87

Essentials

Size & Ordering Information
Designers Portal

136-140

140

141

Install Showcase

142-143

Guides

144-149

New Featured Items



School Seating
Zed Rocker Chair
PAGE 20



Soft Seating
Re•Group Rocker Chair
PAGE 32



Soft Seating
Re•Group Bench with Back and Arm Rest
PAGE 34



Hard-Plastic Student Desk Option
Driftwood HP & Sky Rise HP
PAGE 147



Standard Laminate Option
32 New Laminate Colors
PAGE 147



Media Center
Circulation Desk
PAGE 124



LE-SUEUR-HENDERSON ELEMENTARY - LE SUEUR, MN



Inspiration Series – School Chair
The Mod Series® – Basic Mod® Shapes
Hercules Series – Round Table

THE MORE THAT YOU READ, THE MORE THINGS YOU WILL KNOW, THE MORE THAT YOU LEARN, THE MORE PLACES



BARRIE SCHOOL - SILVER SPRING, MD

Student Voice & Respo



Illustration V2 Series – Seminar and Computer Table
Zed Series – School Chair

onsibility

Active Learning

Diversity, Equity, & Inclusion



KIRKLAND RANCH - WESLEY CHAPEL, FL



Inspiration Series – School Chair
Surge Series – School Desk
Junction – School Desk
Nate Series – Teacher Desk



Soft Seating – The Mod Series® Soft Seating

INDIAN HILL ELEMENTARY SCHOOL - CINCINNATI, OH



Soft Seating – The Mod Series® Soft Seating

School Environments

Zed Series – Cantilever Chair
The Mod Series® – Large Hexagon Mod®
Dura Series – Chad Table



Active Classroom – Squirle® Active Seating Stool

MAX LARSEN ELEMENTARY SCHOOL - COLDWATER, MI



- Zed Series – School Chair
- Squirrel® – Active Seating Stool
- The Mod Series® – Round Mod®
- The Mod Series® – Mod® Table
- Hercules Series – Rectangle Table



BLIND BROOK MIDDLE SCHOOL - RYE BROOK, NY



Inspiration Series – School Chair
Petal Series – School Desk
Surge Series – School Desk
The Mod Series® – Arc Mod®
Hercules Series – Clover Table
Harmony Series – Chord Table



CHESAPEAKE SCIENCE POINT - HANOVER, MD

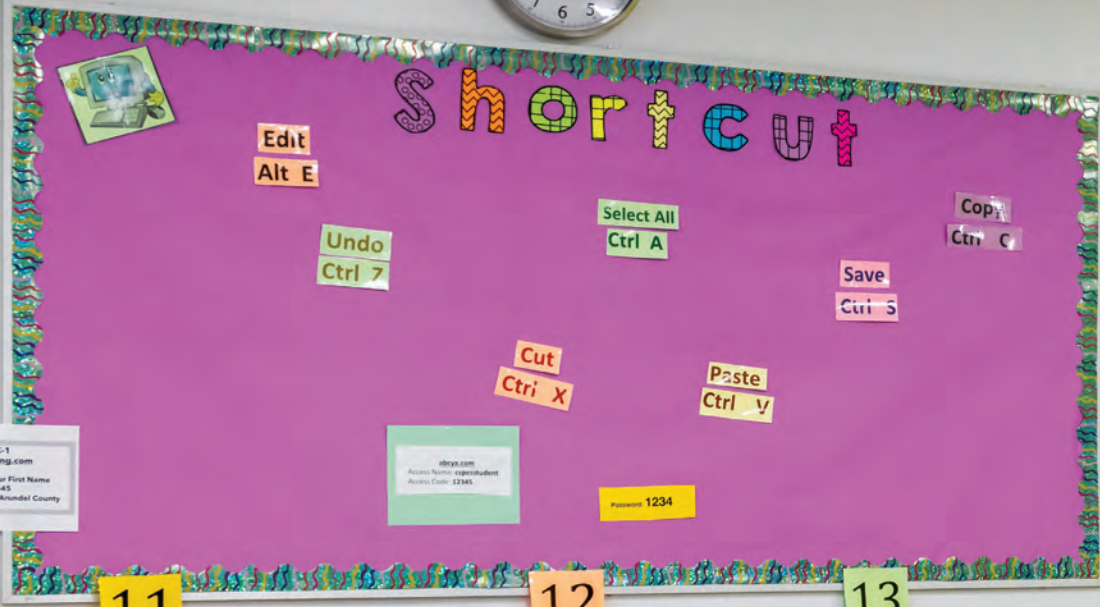

11

12

13

14

15



Zed Series – School Chair
Illustration V2 Series – Computer Table



KIRKWOOD ELEMENTARY SCHOOL - CLARKSVILLE, TN





Zed Series – School Chair
Hercules Series – Rectangle Table
Boost Series – Square Café Table & Zed Café Stool
Re-Group Series - Bench with Back



Zed Series – School Chair



Z28RG - **NEW** Zed Rocker Chair



Researched to meet educational seating needs, the Zed Chair offers exceptional comfort, a sleek, extra-wide design for all ages, and hybrid engineering for lightweight durability, minimized stress, and a flawless, long-lasting finish.





Z28 - Value Chair



Z18WBB - Standard Chair with Bookbasket



Z68B - Cantilever Chair



Z28C - Value with Casters



Z58 - Computer Chair



Z58D - Drafting Stool



Z28RG - **NEW** Zed Rocker Chair



Z424G - 24" Zed Café Stool



Z430G - 30" Zed Café Stool



Z28RG - **NEW** Zed Rocker Chair
Rubber Glides Base



Z68B - Black Frame
Powder Coat



Carry Handle
Smooth Back
Underseat Rivets
Flex of Back

SEAT

Shell: Color-Impregnated Polypropylene Injection and Gas Assist Molded Plastic with Built-In Carry Handle

Back: Smooth and Secure Shell Back

FRAME

Standard & Value Chair*: Chrome-Plated 1" Round, 16-Gauge Steel

Bookbasket (WBB): Chrome-plated ¼" rod steel: 14½"W × 12"D × 8"H. (Only Available on Chrome-Plated Frame Standard & Value Chair)

Boots (Standard Chair Only): Color-Impregnated Polypropylene Plastic

Glides: Self-Adjusting Nylon

Cantilever Chair*: 12-gauge steel legs. Rubber bumpers to protect and grip the table top.

Glides & Inserts: Color coordinated injection molded sled base glide housing to accommodate a choice of four glide inserts; nylon, felt, steel or rubber. Select finish at the time of ordering.

Computer Chair/Drafting Stool: Pneumatic Lift, Adjustable Gas Lift Cylinder, and 5-Star Plastic Swivel Base on Five Casters (Stationary Glides are Optional)

Drafting Stool Only: Chrome-Plated Foot Ring

Café Stool*: See page for 130-131 details.

Rocker Chair*: 16-gauge steel legs. Twin rubber rocker base with anti-tip safety feature.

Casters: Must be installed on-site.

*Standard, Value, Cantilever Chair, Rocker Chair and Café Stool Available in Gray (G) Powder Coating or Black (B) Powder Coating

Optional Items: Glide Caps (Felt, Rubber and Steel), Stationary Bell Glides (for 5-Star Swivel Computer Chairs) can be requested instead of Casters at the time of ordering.



688 - Cantilever Chair



Blending modern trends and colors, this stackable chair offers exceptional support with dual curves and flex-action back. Its durable 16-gauge steel frame, flexible polypropylene shell, and stylish details make it truly inspiring.





618 - Standard Chair



718 - Value Chair



718SB - Sled Base Chair



718C - Value Chair
with Casters



658X - Computer Chair
(Shown with optional
stationary bell glide)



658D - Drafting
Stool



7430 - 30" Inspiration
Café Stool



Carry Handle

Flex of Back

Undersat
Rivets



Back with Ribs

SEAT

Shell: Color-Impregnated Polypropylene Molded Plastic with Built-In Carry Handle

Back: Integral Lumbar Supports

Pads (P): Available on chairs 16" and above. Available in Black, Burgundy, Navy and Custom.

FRAME

Standard & Value Chair: Chrome-Plated, 1" Round, 16-Gauge Steel

Bookbasket (WBB): Chrome-plated ¼" rod steel: 14½"W × 12"D × 8"H.

Boots (Standard Chair Only): Color-Impregnated Polypropylene Plastic

Glides: Self-Adjusting Nylon

Sled-Base Chair: 16 - gauge chrome-plated steel.

Cantilever Chair: 12-gauge steel legs.

Cantilever X-Plus: ¾" added steel tube for leg support and larger shell for added support.

Glides & Inserts: Color coordinated injection molded sled base glide housing to accommodate a choice of four glide inserts; nylon, felt, steel or rubber. Select finish at the time of ordering.

Computer Chair/Drafting Stool: Pneumatic Lift, Adjustable Gas Lift Cylinder, and 5-Star Plastic Swivel Base on Five Casters (Stationary Glides are Optional)

Drafting Stool Only: Chrome-Plated Foot Ring

Café Stool: See page for 130-131 details.

X-Plus(X): Larger shell and Frame for added weight capacity available.

Casters: Must be installed on-site.

Optional Items: Glide Caps (Felt, Rubber and Steel), Stationary Bell Glides (for 5-Star Swivel Computer Chairs) can be requested instead of Casters at the time of ordering.



128 - 18" Classic Chair



Our classic chair features a timeless design with a vented, curved back, durable polypropylene shell, chrome-plated steel legs, and 14-gauge brackets. Available in five sizes with self-adjusting glides.





128WBB - Chair with Bookbasket



128M - Music Chair



128SB - Sled-Base Chair



128C - Chair with Casters



158P - Computer Chair with Pads



158D - Drafting Stool



Steel Back Supports



Waterfall Edge Front



Full-Contact Welds

14-Gauge Underseat Steel

SEAT

Shell: Injection-Molded Polypropylene Plastic with Built-In Supports and Waterfall Front

Back: Vented Back

Pads (P): Available on chairs 16" and above. Available in Black, Burgundy, Navy and Custom.

FRAME

Frame: 1 1/8" Round, 18-Gauge Chrome-Plated Steel (1" Round For 12" & 14" Chairs)

Back Support: 3/4" Round, 16-Gauge Chrome-Plated Steel

Underseat Brackets: Two 14-Gauge, Plated Steel

Bookbasket (WBB): Chrome-plated 1/4" rod steel: 14 1/2"W x 12"D x 8"H.

Glides: Self-Adjusting Nylon

Sled-Base Chair: 3/4" round 16-gauge chrome-plated steel.

Computer Chair/Drafting Stool: Pneumatic Lift, Adjustable Gas Lift Cylinder, and 5-Star Plastic Swivel Base On Five Casters (Stationary Glides are Optional)

Drafting Stool Only: Chrome-Plated Foot Ring

Casters: Must be installed on-site.

Optional Items: Glide Caps (Felt, Rubber and Steel), Stationary Bell Glides (for 5-Star Swivel Computer Chairs) can be requested instead of Casters at the time of ordering.



518 - 18" Hard Plastic Chair



Designed for comfort and durability with a contoured hard-plastic seat, optimal back support, 16-gauge steel legs, and secure upside-down desk stacking. Available in multiple sizes with robust steel back supports.





518 - 18" Hard Plastic Chair



518WBB - Chair w/ Bookbasket



558 - Computer Chair



518C - Chair w/ Casters



558D - Drafting Stool



Fix. Ht.
4530WB - Hard Plastic Stool with Back



Adj. Ht.
4518AWB - Hard Plastic Stool with Back



Gooseneck Back Supports



Unitized Frame with 6 Point Weld



Underside of Chair

SEAT

Back: 3/8" Thick Hard-Plastic 13 1/2" W X 6 3/8" L

Seat: 3/8" Thick Hard Plastic

FRAME

Frame: 1" Round, 16-Gauge Chrome-Plated Steel Welded Frame

Back Support: 3/4" Round, 14-Gauge Chrome-Plated Steel (16-Gauge For 10-14")

Adj. Ht. Stool (4518A & 4518AWB only): 3/4" 18-gauge with Two Self-locking Screws. 18-27" Ht

Bookbasket (WBB): Chrome-plated 1/4" rod steel: 14 1/2"W x 12"D x 8"H.

Foot Ring: 18-Gauge 3/4" Outer-Diameter

Glides: Self-Adjusting Nylon

Computer Chair/Drafting Stool: Pneumatic Lift, Adjustable Gas Lift Cylinder, and 5-Star Plastic Swivel Base On Five Casters (Stationary Glides are Optional)

Drafting Stool Only: Chrome-Plated Foot Ring

Hard Plastic Stool with Back: Chrome-Plated 7/8" 18-Gauge

Glides: Self-Adjusting Nickel-Plated Casing With Nylon Inserts

Casters: Must be installed on-site.

Optional Items: Glide Caps (Felt, Rubber and Steel). Stationary Bell Glides (for 5-Star Swivel Computer Chairs) can be requested instead of Casters at the time of ordering.

Squircle® – Active Seating Stool



Squircle Cluster



Squircle® adds style to classrooms, libraries, or lounges with 14 color options, 4 height options, and a swaying dome base. Lightweight, durable, and adjustable with a foam seat and grab handle.





SQA - 15½ - 19½"

SQ-18 - 18"

SQ-15 - 15"

SQ-13 - 13"

SEAT

Seat Top: Polypropylene & Foam Center. Waterfall Edge Seat Doubles as Grab Handle. 12½"D

BASE

Rubber Base: Shaped to wobble, not topple, with rubber overmold, nonslip protection that ensures feet rest firmly on chair.

Angled Base: 13"

Fixed Ht. Option: 18", 15" and 13"

Adjustable Ht. Option: Adjusts 15½-19½"

"Squircle" is a registered trademark of Academia Furniture Industries.



Waterfall Edge Seat



Adjustable Handle



Rubber Base



SQ-18 & HS-3152CD -
Active Seating Stool & Harmony Chord Table



SQ-18, SQA & HLS-4254CU -
Active Seating Stool & Hercules Curved Toddler Ht. Table



Zed Series – School Chair

Seat Ht."	W × D"	Frame Color		
		Chrome	Gray PC*	Black PC*
Standard				
12"	12¾ × 12"	Z12	Z12G	Z12B
14	12¾ × 12	Z14	Z14G	Z14B
16	17 × 16	Z16	Z16G	Z16B
17½	17 × 16	Z18	Z18G	Z18B
18½	17 × 16	Z19	Z19G	Z19B
Standard w/ Bookbasket				
14	12¾ × 12"	Z14WBB	—	—
16	17 × 16	Z16WBB	—	—
17½	17 × 16	Z18WBB	—	—
18½	17 × 16	Z19WBB	—	—
Value				
12"	12¾ × 12"	Z22	Z22G	Z22B
14	12¾ × 12	Z24	Z24G	Z24B
16	17 × 16	Z26	Z26G	Z26B
17½	17 × 16	Z28	Z28G	Z28B
18½	17 × 16	Z29	Z29G	Z29B
Value w/ Bookbasket				
14	12¾ × 12"	Z24WBB	—	—
16	17 × 16	Z26WBB	—	—
17½	17 × 16	Z28WBB	—	—
18½	17 × 16	Z29WBB	—	—
Cantilever Chair				
12"	12¾ × 12"	Z62	Z62G	Z62B
14	12¾ × 12	Z64	Z64G	Z64B
16	17 × 16	Z66	Z66G	Z66B
18	17 × 16	Z68	Z68G	Z68B
19	17 × 16	Z69	Z69G	Z69B
Casters				
16"	17 × 16"	Z26C	Z26CG	Z26CB
18	17 × 16	Z28C	Z28CG	Z28CB
Casters w/ Bookbasket				
16"	17 × 16"	Z26CWBB	—	—
18	17 × 16	Z28CWBB	—	—
Computer Chair				
17-23"	17 × 16"	Z58	—	—
Drafting Stool				
24-33"	17 × 16"	Z58D	—	—
Boost Café Stools				
24"	19½ × 22½"	Z424	Z424G	Z424B
30	19½ × 22½"	Z430	Z430G	Z430B
Rocker Chair				
18"	19½ × 33½"	Z28R	Z28RG	Z28RB

*Powder Coating: Not available with Bookbasket (WBB), Computer Chair and Drafting Stool.

Optional Items: Glide Caps (Felt, Rubber and Steel), Stationary Bell Glides (for 5-Star Swivel Computer Chairs) can be requested instead of Casters at the time of ordering.



Inspiration Series – School Chair

Seat Ht."	W × D"	Frame Color
		Chrome
Standard		
11½"	12¼ × 12"	612
13½	12¼ × 12	614
16¼	16 × 16	616
17¾	16 × 16	618
17¾	17¾ × 16	618X
19	16 × 16	619
18½	17¾ × 16	619X
Value		
11½"	12¼ × 12"	712
13½	12¼ × 12	714
16¼	16 × 16	716
17¾	16 × 16	718
17¾	17¾ × 16	718X
19	16 × 16	719
18½	17¾ × 16	719X
Standard w/ Bookbasket		
13½	12¼ × 12"	614WBB
16¼	16 × 16	616WBB
17¾	16 × 16	618WBB
17¾	17¾ × 16	618XWBB
19	16 × 16	619WBB
18½	17¾ × 16	619XWBB
Value w/ Bookbasket		
13½	12¼ × 12"	714WBB
16¼	16 × 16	716WBB
17¾	16 × 16	718WBB
17¾	17¾ × 16	718XWBB
19	16 × 16	719WBB
18½	17¾ × 16	719XWBB
Cantilever Chair		
12"	12¼ × 12"	682
14	12¼ × 12	684
16¼	16 × 16	686
18	16 × 16	688
18	17¾ × 16	688X
19	16 × 16	689
19½	17¾ × 16	689X
Casters		
16¼	16 × 16"	716C
19½	16 × 16	718C
Sled Base		
18	16 × 16"	718SB
Computer Chair		
17-23"	16 × 16"	658
17-23	17¾ × 16	658X
Drafting Stool		
24-33"	16 × 16"	658D
24-33	17¾ × 16	658XD
Boost Café Stools		
24"	19½ × 22½"	7424
30	19½ × 22½"	7430

For Pads (P)* add Suffix to the Model Number Above
P

*Pads (P): Available on chairs 16" and above. Available in Black, Burgundy, Navy and Custom.

Optional Items: Glide Caps (Felt, Rubber and Steel), Stationary Bell Glides (for 5-Star Swivel Computer Chairs) can be requested instead of Casters at the time of ordering.

Bookbasket (WBB) must be installed by manufacturer. • All heights listed are within ¾" variants.



Classic Series – School Chair

Seat Ht."	W × D"	Model
11¾"	13 × 12"	122
14	13 × 12	124
16½	16¼ × 15	126
18¼	16¼ × 15	128
19¼	16¼ × 15	129
w/ Bookbasket		
14	13 × 12"	124WBB
16½	16¼ × 15	126WBB
18¼	16¼ × 15	128WBB
19¼	16¼ × 15	129WBB
Casters		
16"	16¼ × 15"	126C
18	16¼ × 15	128C
Music Chair		
17¾"	16¼ × 15"	128M
Sled Base		
18"	16¼ × 15"	128SB
Computer Chair		
17-23"	16¼ × 15"	158
Drafting Stool		
24½-29½"	16¼ × 15"	158D
For Pads (P)* add Suffix to the Model Number Above		
P		

*Pads (P): Available on chairs 16" and above. Available in Black, Burgundy, Navy and Custom.

Optional Items: Glide Caps (Felt, Rubber and Steel), Stationary Bell Glides (for 5-Star Swivel Computer Chairs) can be requested instead of Casters at the time of ordering.



Hard Plastic Series – School Chair

Seat Ht."	W × D"	Model
12½-15½"	13½ × 13"	510A
12	13½ × 13	512
14	13½ × 13	514
15¾	15¾ × 15	516
17¾	15¾ × 15	518
18¾	15¾ × 15	519
w/ Bookbasket		
14	13½ × 13"	514WBB
15¾	15¾ × 15	516WBB
17¾	15¾ × 15	518WBB
18¾	15¾ × 15	519WBB
Casters		
18¾"	15¾ × 15"	518C
Computer Chair		
17-23"	15¾ × 15"	558
Drafting Stool		
24½-29½"	15¾ × 15"	558D
Hard Plastic Stool with Back		
18-24"	14 × 14"	4518AWB
18	14 × 14	4518WB
24	16 × 16	4524WB
30	18 × 18	4530WB

Optional Items: Glide Caps (Felt, Rubber and Steel). Stationary Bell Glides (for 5-Star Swivel Computer Chairs) can be requested instead of Casters at the time of ordering.

Bookbasket (WBB) must be installed by manufacturer. • All heights listed are within ¼" variants.



Squirrelle® – Active Seating Stool

Seat Ht."	W × D"	Model
Active Seating Stool		
13"	13 × 13"	SQ-13
15	13 × 13	SQ-15
18	13 × 13	SQ-18
15½-19½	13 × 13	SQA

Size Chart

Approximate Chair Size Suggestions

Ht. of Chair Seat	12"	14"	16"	18"	19"
Preschool-K	•	•			
Grade 1		•			
Grade 2		•	•		
Grade 3			•		
Grade 4			•	•	
Grade 5 - 12				•	•



REB20R - NEW Re•Group Rocker Chair



Re•Group offers unmatched versatility with customizable shapes, colors, and patterns. Crafted with durable wood, resilient foam, and French triple seams, it combines comfort, style, and long-lasting quality.





REB42 - **Bench with Back**
(With Flush Power Port)



RE86 - **Chaise Lounge**

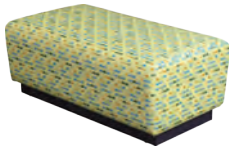

RE42 - **Bench**



RE28-I-LAM - **Inside Corner**

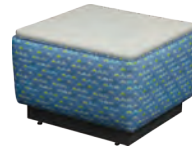

RE24-LAM - **Ottoman**



REB20R - **NEW Re•Group Rocker Chair**
(Front View)



REB20R - **NEW Re•Group Rocker Chair**
(Back View with Built-in Handle Bar)



REB20R - **NEW Re•Group Rocker Chair**
(Side View)

SEATING

Seat and Back: Polyurethane foam surrounds a 3/4" plywood frame supported by multiple 1 x 2 wooden pegs.

Textiles: 6 different grade options

Glides: Adjustable 1" glide

Base: 3" powder-coated textured steel base.

Rocker Chair Base: Twin Rubber Glides

Ottoman & RE28-I-LAM

Tabletop: 3/4" laminate top

Edge Banding: Standard T-Mold edge banding with any standard color.

Glides: Adjustable 1" glide

Power: Various power port options available on Bench sides, or Power Shelf.



Laminate Ottoman with
Signature Welt Piping

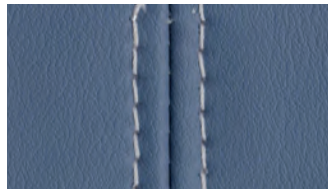

French Stitching



Bench with Flush
Power Port



Solid Metal Base Frame



Underside Base and Glide
with Standard Ganging



Rocker Chair Twin
Rubber Glides Base



Scan to Watch Demo



Re•Group Series - Arm Rest



NEW Oval Configuration with Floating Arms
(REB36-FLT, RE26-0-FLT and RE36-SHF)

”

Re•Group offers unmatched versatility with customizable shapes, colors, and patterns. Crafted with durable wood, resilient foam, and French triple seams, it combines comfort, style, and long-lasting quality.

”



Bench with Back and Arm Rest Configuration
(REB62-ARM, RE28-I-LAM with Laminate Top)



REB42-ARM - **NEW** Bench
with Back and Arm Rest



REB62-ARM - **NEW** Bench
with Back and Arm Rest



REB24-ARM - **NEW** Bench
with Back and Arm Rest

SEATING

Seat and Back: Polyurethane foam surrounds a 3/4" plywood frame supported by multiple 1 x 2 wooden pegs.

Floating Arm: Floating arm rest is 4 1/2" wide. There is a heavy gauge metal holding plate that is flush on the outside but securely bolted internally to the wood frame to support the arm rest.

Arm Rest: Arm rest is 6" wide and 20 1/2" tall. Same solid core as seat and back - wooden frame with pegs and polyurethane foam. Flush Power options available.

Textiles: 6 different grade options

Glides: Adjustable 1" glide

Base: 3" powder-coated textured steel base.

Ottoman & RE28-I-LAM

Tabletop: 3/4" laminate top

Edge Banding: Standard T-Mold edge banding with any standard color.

Glides: Adjustable 1" glide

Power: Various power port options available on front of Armrests, Bench sides, or Power Shelf.



RE-SHF - Power Shelf



Configuration with
RE-SHF - Power Shelf



Arm Rest with Flush
Power Port



Floating Arm Rest Flush
Metal Plate



Underside Base and Glide
with Standard Ganging



Solid Metal Base Frame



Scan to Watch Demo



The Mod Series® – Basic Mod® Shapes



8136-LAM - **NEW** Drop Mod®
with Laminate Top



Mod® offers cushiony, cozy seating with high-density foam, available in various shapes, heights, and configurations. Pair with Mod® tables and choose from any Momentum Textiles for durability and resistance.



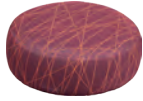

8104 - Pebble Mod®



8118 - Round Mod®



8318 - Square Mod®



8418 - Square Corner Mod®



8518 - Hexagon Mod®



8538 - Large Hexagon Mod®

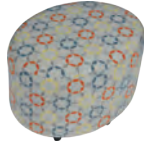

8128 - Oval Mod®



8136 - NEW Drop Mod®



8328 - Trapezoid Mod®



8618 - Rectangular Mod®



8030R - Mod® Table
(Shown in Laminate White Drops)



8138 - 30" Round Mod®



8138-LAM - 30" Round Mod®
with Laminate Top
8218 - Semi Round Mod®



8138-LAM - 30" Round Mod®
with Laminate Top
(Shown with Power Port)

SEATING

Basic Mod® Shape

Seat: Polyurethane foam surrounds a ¾" plywood frame supported by multiple 1 × 2 wooden pegs

Textiles: 6 Different Grade Options

Casters/Glides: Compatible with 1 ½" twin casters or stationary rubber glides

Optional Compression Casters: Locks when seated
See pages 42-43 for details.

Pebble Mod® Shape

Seat: Polyurethane Foam Core With ½" Plywood Base

Nail Glides: Underneath Pebble

MOD® TABLE

Tabletop: High Pressure Laminate

8020SQ Square Mod® Table: 22 × 22" Top

Edge Banding: PVC 3mm edge banding; Standard in White.

8030R Round Mod® Table: 30" R Top

Edge Banding: Hydraulically inserted T-mold edge banding; Color edge band available.

Frame: 1" Square 18 Gauge Welded Steel

Glides: Height Adjustable Glides

Optional Items: Stationary Glides and Compression Casters

"The Mod Series" & "Mod" are registered trademarks of Academia Furniture Industries.



Inner Pebble Mod Frame



French Stitching



Glide



Caster



Compression Casters



The Mod Series® – Mod® with Back



Comfortable high-density foam seating in various shapes and heights. Mix and match for endless configurations. Available in six Momentum Textiles options, including pen-resistant, water-resistant, and antibacterial choices.

Configure in Groups
8818 - 2 Step Mod® & 8828 - 3 Step Mod®

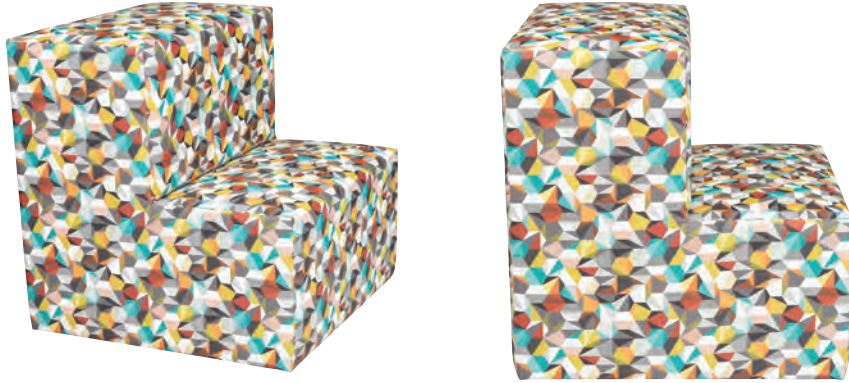

8818 - 2 Step Mod®

SEATING

Seat: Polyurethane foam surrounds a 3/4" plywood frame supported by multiple 1 x 2 wooden pegs

Textiles: 6 Different Grade Options

Nail Glides: Underneath 2 Step, 3 Step, Outside Corner & Inside Corner

Legs: Available on 1/4 Back & 3/4 Back Only. Brushed steel, 2 1/4" Dia. x 5"H

"The Mod Series" & "Mod" are registered trademarks of Academia Furniture Industries.



8828 - 3 Step Mod®

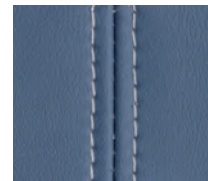

French Stitching



Nail Glide



Configure in Groups
8848 - Outside Corner Mod®, 8818 - 2 Step Mod® &
8838 - Inverted Corner Mod®



Inner Mod Frame





8717 & 8708 - Arc 4 Mod® Combo



Mod® Soft Seating offers cushiony, cozy seating with high-density foam, available in various shapes and heights. Pair with café or Mod® tables, and choose from six grades of Momentum Textiles options for durability and resistance.





8717 - Arc 4 Mod®
with Backrest



8708 - Mega 4 Mod®



Create a 2nd side on a "couch"
(8717 & 8708 - Arc 4 Mod® Combo)



8717-SHELF - Arc 4 Mod® with
Backrest & Shelf



8718 - Arc 4 Mod® with
CF-30R - Café Table



8728 - Arc 6 Mod® with
8020SQ - Mod® Table



8888 - Rainbow Mod®



8718 - Arc 4 Mod®

SEATING

Seat: Polyurethane foam surrounds a 3/4" plywood frame supported by multiple 1 x 2 wooden pegs

Textiles: 6 Different Grade Options

Casters/Glides: Compatible with 1 1/2" twin casters or stationary rubber glides.

Optional Compression Casters: Locks when seated
See pages 42-43 for details.

SHELF

Top: 5/8" Thick High-Pressure Laminate

Edge Banding: PVC 3mm edge banding. Standard Black, White or Gray Edge, Custom Colors available.

MOD® TABLE

Tabletop: High Pressure Laminate

8020SQ Square Mod® Table: 22 x 22" Top

Edge Banding: PVC 3mm edge banding; Standard in White.

8030R Round Mod® Table: 30" R Top

Edge Banding: Hydraulically inserted T-mold edge banding; Color edge band available.

Frame: 1" Square 18 Gauge Welded Steel

Glides: Height Adjustable Glides

Optional Items: Stationary Glides and Compression Casters

"The Mod Series" & "Mod" are registered trademarks of Academia Furniture Industries.



French Stitching



Glide



Caster



Compression Casters

Scan to Watch Demo



The Mod Series® – Basic Mod® Shapes



Seat Ht."	W × D"	Casters / Glides	Model
Mod® Table -8000			
18½"	22 × 22"	--	8020SQ*
18½"	30 × 30"	--	8030RD*
Round Mod® -8100			
13½"	13 × 13"	5	8114
17½"	17 × 17"	5	8118
14"	24 × 24"	4	8124-ROUND
18"	24 × 24"	4	8128-ROUND
18"	30 × 30"	6	8138
30" Round Mod® w/ Laminate Top			
18"	30 × 30"	6	8138-LAM
Semi-Round Mod® -8200			
13½"	13 × 13"	5	8214
17½"	17 × 17"	5	8218
Square Mod® -8300			
13½"	13 × 13"	4	8314
17½"	17 × 17"	4	8318
Square Corner Mod® -8400			
13½"	13 × 13"	4	8414
17½"	17 × 17"	4	8418
Hexagon Mod® -8500			
13½"	13 × 13"	5	8514
17½"	17 × 17"	6	8518
Large Hexagon Mod® -8538			
16"	36 × 24"	6	8538
Large Hexagon Mod® -8538 w/ Laminate Top			
16"	36 × 24"	6	8538-LAM
Rectangle Mod® -8600			
13½"	26 × 13"	6	8614
17½"	34 × 17"	6	8618
Pebble Mod®			
4½"	14 × 14"	4	8104
Trapezoid Mod®			
14"	36 × 18"	4	8324
18"	36 × 18"	4	8328
Oval Mod®			
14"	28¼ × 21½"	6	8124-OVAL
18"	28¼ × 21½"	6	8128-OVAL
Drop Mod®			
16"	36 × 24"	4	8136
Drop Mod® w/ Laminate Top			
16"	36 × 24"	4	8136-LAM

The Mod Series® – Mod® with Back



Seat Ht."	W × D"	Model
2 Step Mod®		
36"	36 × 36"	8818
3 Step Mod®		
36"	36 × 36"	8828
Outside Corner Mod®		
18"	36 × 36"	8848
Inverted Corner Mod®		
18"	36 × 36"	8838



Edge Finish & Color Options

Square Mod® Table

PVC 3mm edge banding; Standard in White.

Round Mod® Table & Basic Mod® Shapes Laminate Top (LAM)

Hydraulically inserted T-mold edge banding; Color edge band available.

See page 146 for more details.

Note the color needed at the time of ordering • All heights listed are within ¼" variants. Casters add 2-3" to the overall height.

The Mod Series® – Arc Mod®



Seat Ht."	W x D"	Casters / Glides	Model
Arc 4 -8700			
14"	56½" x 24¾"	6	8714
18"	56½" x 24¾"	6	8718
Arc 4 with Backrest			
14"	70½" x 33½"	6	8713
18"	70½" x 33½"	8	8717
Mega 4 Mod®			
14"	95 x 31½"	7	8704
18"	95 x 31½"	9	8708
Arc 6 -8700			
14"	44 x 18"	6	8724
18"	44 x 18"	6	8728
Arc 6 with Backrest			
14"	52 x 30"	5	8723
18"	52 x 30"	6	8727
Mega 6 Mod®			
14"	68½" x 23½"	7	8703
18"	68½" x 23½"	7	8707
Arc 4 Mod® with Backrest & Shelf			
14"	70½" x 33½"	6	8713-SHELF
18"	70½" x 33½"	8	8717-SHELF
Arc 6 Mod® with Backrest & Shelf			
14"	52 x 30"	5	8723-SHELF
18"	52 x 30"	6	8727-SHELF
Rainbow Mod®			
30"	75½" x 45"	5	8888

Optional Items: Stationary Glides on Basic & Arc Shapes Soft Seating.
 "The Mod Series" & "Mod" are registered trademarks of Academia Furniture Industries.



Edge Finish & Color Options

Arc Mod® with Backrest & Shelf

PVC 3mm edge banding. Standard Black, White or Gray Edge, Custom Colors available.

Re•Group Shapes Laminate Top (LAM)

Hydraulically inserted T-mold edge banding; Color edge band available.

See page 146 for more details.

Note the color needed at the time of ordering • All heights listed are within ¾" variants. Casters add 2-3" to the overall height.

Re•Group Series



Seat Ht."	W x D"	Model
Bench		
18"	36 x 24"	RE36
18"	42 x 24"	RE42
Bench w/ Back		
18"	36 x 24"	REB36
18"	42 x 24"	REB42
Chaise Lounge		
18"	86 x 35"	RE86
Inside Corner		
18"	28 x 28"	REB28-I
Inside Corner w/ Laminate Top		
18"	28 x 28"	RE28-I-LAM
Outside Corner w/ Back		
18"	26 x 26"	REB26-O
Ottoman w/ Laminate Top		
16"	22 x 22"	RE24-LAM
Re•Group Rocker Chair		
18"	20 x 24"	REB20R
Shelf		
29"	41 x 30"	RE36-SHF
29"	47 x 30"	RE42-SHF

Re•Group Series - Arm Rests



Seat Ht."	W x D"	Model
Bench w/ Back & Two Arm		
18"	35 x 24"	REB24-ARM
18"	48 x 24"	REB36-ARM
18"	53 x 24"	REB42-ARM
18"	73 x 24"	REB62-ARM
Bench w/ Back & One Left Arm		
18"	35 x 24"	REB24-ARM-LH
18"	48 x 24"	REB36-ARM-LH
18"	53 x 24"	REB42-ARM-LH
18"	73 x 24"	REB62-ARM-LH
Bench w/ Back & One Right Arm		
18"	35 x 24"	REB24-ARM-RH
18"	48 x 24"	REB36-ARM-RH
18"	53 x 24"	REB42-ARM-RH
18"	73 x 24"	REB62-ARM-RH
Bench w/ Back & One Right Floating Arm		
18"	41 x 24"	REB36-FLT
18"	46 x 24"	REB42-FLT
Outside Corner w/ Back & One Right Floating Arm		
18"	40 x 26"	REB26-O-FLT

S4 Stacking Series – School Desk



Adj. Ht.
4400A - S4 Student Desk
(Shown in Driftwood Laminate and
X-Strong Edge in Primary Blue)



Stacks 4 high with locking casters for easy rearranging. Concave and convex sides enable versatile collaboration. Spacious surface seats two, gap-free when paired. Durable unitized frame in 7 standard or custom colors.





Fix. Ht.
4429 - S4 Student Desk



Adj. Ht.
4400A - S4 Student Desk
(Shown in Driftwood Laminate and X-Strong Edge in Primary Blue)



4429 - S4 Student Desk Stacked

TOP

Work Surface: 520 Sq. Inches

Desktop: Fiberboard 5/8" Thick High Pressure Laminate
29"W x 20"D

FRAME

Utilized Frame: 1 1/2" Steel Round 17 Gauge Legs With 17 Gauge Upper Frame.

Bumpers: The desk's frame features 6 protective bumpers to avoid any scratches for safe stacking.

Legs: Wheelbarrow Style Legs w/ Ht. Adj. Nylon Glide

Adj. Ht. Desk

Insert Legs: 1 1/4" Insert Leg Tube
Height Adjustable: 21-33" H

Casters: 2" Locking Casters

HIGH PRESSURE LAMINATE EDGE FINISH

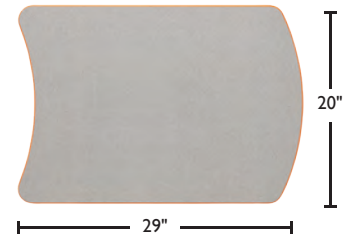

Pod of 4 PVC 3mm Edge

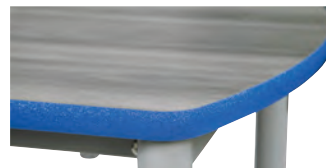

Edge and Frame



S4 Desk with PVC 3mm Edge in Lime Green and Primary Green



Locking Casters



Fully Unitized Frame

Synco Series – School Desk



With its organic trapezium shape, this table is ideal solo or as pods. Easily adjustable heights, swivel casters, and minimal footprint offer expansive knee room and full tabletop use.



5400 - Synco Desk
(Shown in Standard Enrich Laminate, and Aqua X-Strong Edge)



5400 - **Synco Desk Back**
(Shown in Primary Red T-Mold Edge)

TOP

Work Surface: Dimensions are 33.5" wide by 22" deep. 638 Sq. inches total.

Desktop: 1 1/8" thick fiberboard high pressure laminate surface.

FRAME

Upper Legs: Powder-coated 1.5" diameter: 16 gauge.

Insert Legs: Powder-coated 1.35" diameter: 16 gauge with two self-locking screws.

Height Adjustable: Adjusts 26-33" with glides. Legs adjust in 1" increments.

Wheelbarrow Option: Available.

Casters/Glides: Ht. Adj. glides (standard) or casters (optional)

HIGH PRESSURE LAMINATE EDGE FINISH



Synco Desk - Pod of 3
(Shown with Mesh Book Box, ClearThin Bin, Wire Book Box)

Optional Items: Bookboxes, Casters, Grommets, Hooks and Power.



Pod of 4
29 sq. ft of classroom space

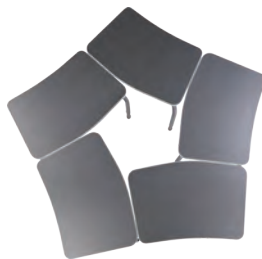

Pod of 5
36 sq. ft of classroom space

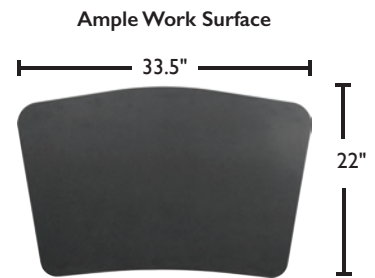

Ample Work Surface



Adjustable Legs Compatible with Casters or Glides



Heavy Duty Support Plate



Height Adjustable Glide

Junction – School Desk



5300 - Junction Desk
(Shown in Driftwood Laminate and Aqua X-Strong Edge)

“

Designed for flexibility, this desk offers a book basket, height adjustability, and intuitive pod configurations. It's durable and space-efficient, perfect for individual or group use.

”



5300 - Right Handed
Junction Desk



5300LH - Left Handed
Junction Desk

TOP

Work Surface: 702 Sq. Inches

Desktop: 1 1/8" Thick High Pressure Laminate

FRAME

Upper Legs: Powder-Coated 2 1/8" Round 18-Gauge Steel

Insert Legs: Chrome-Plated 2" Round 16-Gauge Steel

Height Adjustable: Legs Adjust In 1" Increments

Casters/Glides: Compatible with Ht. Adj. Glides (Standard) or Casters (Optional)

HIGH PRESSURE LAMINATE EDGE FINISH



Optional Items: Hard and Soft Casters, Mesh Bookbox, Backpack Hook.



Pod of 3
23.7 sq. ft of
classroom space



Pod of 4
34.4 sq. ft of
classroom space

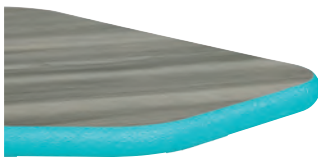
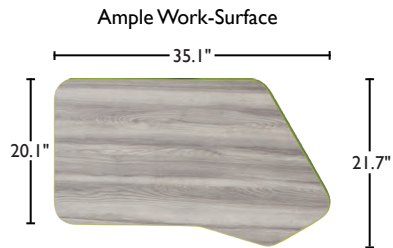

X-Strong Edge in Aqua



Adjustable Legs
Compatible with
Casters or Glides



Heavy Duty Support Plate



Designed for flexibility, this desk offers a book basket, height adjustability, and intuitive pod configurations. With T-molded edges, it's durable and space-efficient, perfect for individual or group use.



5200 - Pod of 6 Desks

(Shown in Standard White Board and custom laminates Wilsonart Ocean #D502, Formica Amarena #6907, Spectrum Blue #851, & Mouse #928 with optional Casters)



Standard Ht.
5200 - Synergy Desk



Standing Ht.
5200SH - Synergy Desk

TOP

Work Surface: 681 Sq. Inches

Desktop: 1 1/8" Thick High Pressure Laminate

FRAME

Desk Supports: Powder Coated 3/4" Square 18 Gauge Steel Tubing

Upper Legs*: Powder-Coated 2 1/8" Round 18-Gauge Steel

Insert Legs: Chrome-Plated 2" Round 16-Gauge Steel with Two Self-Locking Screws

Standing Height Legs Only: Available in Black or Tungsten Color

Height Adjustable: Legs Adjust In 1" Increments

Casters/Glides: Compatible with Ht. Adj. Glides (Standard) or Casters (Optional)

HIGH PRESSURE LAMINATE EDGE FINISH



T-Mold
Standard



X-Strong
Optional



PVC 3mm
Optional

Optional Items: Hard and Soft Casters, Mesh Bookbox, Backpack Hook.

Space Saver

Synergy's multi-shaped options maximize collaborative workspace, while minimizing occupied classroom space.



Pod of 3
31 sq. ft of classroom space



Pod of 4
35 sq. ft of classroom space



Pod of 5
40 sq. ft of classroom space



Pod of 6
44 sq. ft of classroom space

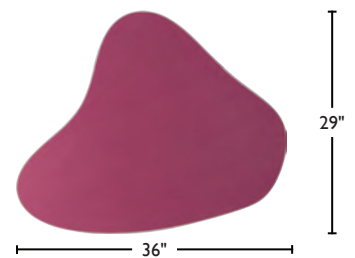

Need help configuring in groups?
Request a complimentary puzzle set.



Adjustable Legs
Compatible with
Casters or Glides



Heavy Duty
Support Plate



Modern design with ample legroom, triangular desktop for versatile configurations, 350+ square inches of space, and a unitized steel frame for stability in any setup.



2000 - Innovation Desks Pod
(Shown in Driftwood Laminate and X-Strong Tangerine Edge)



Standard Ht.
2000 - Innovation Desk



Standing Ht.
2000SH - Innovation Desk
(Shown in Driftwood Laminate and X-Strong Tangerine Edge)

TOP

Work Surface: 350 Sq. Inches

Desktop: 5/8" Thick High Pressure Laminate or Hard Plastic

Hard-Plastic Desktop Colors: Not Available in Light Gray and Beige.

FRAME

Utilized Frame: Triangular Powder-Coated Steel 3/4" Square Tube, 18-Gauge

Upper Legs: Powder-Coated 1 3/8" Round 18-Gauge Steel
Available in Black or Tungsten Gray only

Insert Legs: Chrome-Plated 1 1/4" Round 16-Gauge Steel with Two Self-Locking Screws

Brace (Standing Height Legs Only): 3/4" Round 18-Gauge Steel Adjusts From 10-12"

Height Adjustable: Legs Adjust In 1" Increments

Glides: Poly Propylene Height Adjustable Glides

HIGH PRESSURE LAMINATE EDGE FINISH



T-Mold
Standard



X-Strong
Optional



PVC 3mm
Optional

Optional Items: Backpack Hook, Glide Inserts (Nylon, Felt, Steel or Rubber), Glide Insert Replacements, Mesh Bookbox, Wire Bookrack, and Power Post.



Right-Handed Position



Forward Facing Position



Left-Handed Position

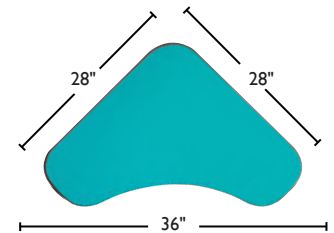

Standing Ht.
2000SH - Innovation Desk
(Shown in Driftwood Laminate and X-Strong Tangerine Edge)



Unitized Frame



New X-Strong Edge
(Shown in Tangerine)

Matching Options



Power Post
See pages 138-139



1900 - Petal Desk
(Shown in Driftwood Laminate with Optional Casters and X-Strong Gray Edge)



Spacious desks with over 500 square inches of desktop area, ideal for collaboration or individual work. Durable Hercules legs and unitized frame ensure long-lasting strength.





Toddler Ht.
1900S - Petal Desk



Standard Ht.
1900 - Petal Desk



Standing Ht.
1900SH - Petal Desk



Petal Desk Pods

TOP

Petal Work Surface: 508 Sq. Inches

Junior Petal Work Surface: 513 Sq. Inches

Desktop: 1 1/8" Thick High Pressure Laminate
Hard-Plastic Desktop Colors: Not Available in Beige.

FRAME

Fully Unitized Frame: Powder Coated 3/4" Square 18 Gauge Steel Tubing

Upper Legs: Powder-Coated 2 1/8" Round 18-Gauge Steel

Insert Legs: Chrome-Plated 2" Round 16-Gauge Steel with 2 Self-Locking Screws

Standing Height Legs Only: Available in Black or Tungsten Color.

Height Adjustable: Legs Adjust In 1" Increments

Casters/Glides: Compatible with Ht. Adj. Glides (Standard) or Casters (Optional)

HIGH PRESSURE LAMINATE EDGE FINISH



Optional Items: Backpack hook, Casters, Mesh Bookbox.

Matching Options



Lazer Teacher Desk
See page 118-119

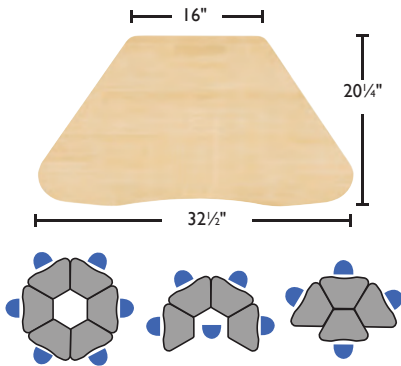

1900 - Petal Desk

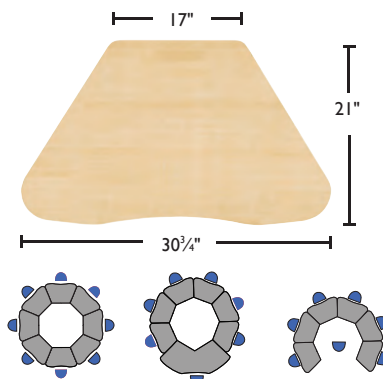

1950 - Junior Petal Desk



Fully Unitized Frame

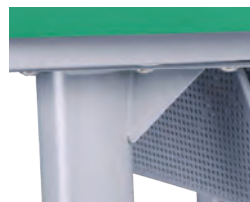

Heavy-duty support plate



New PVC 3mm Edge
(Shown in Primary Green)



Versatile desk allows students to sit or stand, enhancing attentiveness. Fully welded steel frame, safety lever for height adjustment, and a large desktop for teachers. Available in various finishes and colors.



1626 - Surge Desk
(Shown with optional Cup Holder and Mesh Bookbox)



1626 - Surge Desk
(Shown in custom Matrix Blue Top and Grey Pvc 3mm Edge)



1629 - Surge Desk



Optional Cupholder



New & Improved
Pneumatic Lift Mechanism



Tote Bin



Caster and Glide Compatible

TOP

Work Surface: 624 Sq. Inches

Desktop: 1 1/8" Thick High Pressure Laminate

FRAME

Surge Base: Rectangular steel tube structure. 26 x 20" heavy supportive gauge.

Height Adjustable: Pneumatic Lift Mechanism Adjust with 12" Range

Adjustable Ht. Option: 26-38" and 30-42"

Casters/Glides: Standard Casters; available with Ht. Adj. Glides

HIGH PRESSURE LAMINATE EDGE FINISH



T-Mold
Standard



X-Strong
Optional



PVC 3mm
Optional

Optional Items: Backpack Hook, Cup Holder, Mesh Bookbox, Rubber Glides, and Tote Bin.



2726WBB - **Fix Ht V2 Desk** with Book Box
(Shown in New Standard Chrome Yellow Laminate Top & Primary Blue T-Mold Edge)



Designed for all grades, this desk features extra legroom and adjustable height. The 500+ square inch desktop provides ample space for books and laptops, with a durable unitized steel frame.





2700 - **Adj. Ht. V2 Desk**
 (Shown with optional Casters and Mesh Bookbox, in custom laminate Formica White Malachite #9949)



2726WBB - **Fix Ht V2 Desk**
 with Book Box
 (Shown in New Standard Chrome Yellow Laminate Top and Primary Blue T-Mold Edge)



Underside with Crossbar



2729HP - **V2 Desk**
 with Hard Plastic Sky Rise Top
 (Shown with Optional Back Pack Hook)



Adjustable Height

TOP

Work Surface: 520 Sq. Inches

Desktop: 5/8" Thick High Pressure Laminate, 26"W x 19 1/2"D

Pencil Groove: Available on Woodstone and Hard Plastic Desktops Only

FRAME

1" Steel Tube: 12-Gauge Steel, Welded At 90° Angle

Stretcher Bar: 1 1/4" Diameter, 18-Gauge Steel

Adj. Ht. Desk

Upper Legs: Two 1 1/2" Diameter Tubes 16-Gauge Steel

Insert Legs: Two 1 1/8" Diameter 16-Gauge Steel Chrome Legs with Two 18 x 1/2" Machine Screws

Height Adjustable: Legs Adjust In 1" Increments

Fix. Ht. Desk

Double Legs: Two 1 1/4" Diameter Tubes 16-Gauge Steel

Casters/Glides: Compatible with Ht. Adj. Glides (Standard) or Casters (Optional)

HIGH PRESSURE LAMINATE EDGE FINISH



Optional Items: Backpack Hook, Bookbox, Modesty Panel, and Rubber Glides.

T-Leg Series – School Desk



1500WBB - T-Leg Desk with Bookbox
(Shown in New Standard Laminate Gray Fabric and
Tangerine T-Mold)



"This height-adjustable desk features a wide frame for extra legroom, sturdy T-leg design, and a 500+ square inch desktop for books and laptops, all supported by a durable unitized frame.





I500WBB - T-Leg Desk with Bookbox
(Shown in New Standard Laminate Gray Fabric and
Tangerine T-Mold)



I500 - T-Leg Desk

TOP

Work Surface: 520 Sq. Inches

Desktop: Fiberboard 5/8" Thick, 26" W × 19½" D

Bookbox (WBB): Chrome-plated steel bookbox for T-leg Desks 18" W × 16" D × 5" H

FRAME

Color: Light Gray or Black Frame Finish

Stretcher Bar: 6-Gauge Powder-Coated Rectangular Tube, 1½" W × 2½" D, Heavy Duty Bolts with 15-Gauge Angle Iron Support

Upper Legs: 16-Gauge Powder-Coated Rectangular Tubing 1½" W × 2½" D

Insert Legs: 16-Gauge Chrome-Plated Rectangular Tubing 1" W × 2" D with Three Self-Locking Screws

Height Adjustable: Legs Adjust In 1" Increments. With bookbox, the legs adjust from 22-25". Without a bookbox, they can adjust from 22-32".

Glides: Screw-In Style with Nylon Base. Micro-Adjustable

HIGH PRESSURE LAMINATE EDGE FINISH



T-Mold
Standard



X-Strong
Optional



PVC 3mm
Optional

Optional Items: Casters, Mesh Bookbox, and Rubber Glides.

Matching Options



T-Leg Tables
See page 106-107



Cross Bar

Adjustable Height



Bookbox Pencil
Groove

Micro-Adjustable Glide

Standard Series – School Desk with Plastic Bookbox



This desk offers adjustable height, a choice of desktops, and a durable plastic bookbox, all built with a unitized frame design for strength and easy adjustments.



Adj. Ht.
1100U - Standard Desk with U-Brace
(Shown in **NEW** Standard Chrome Yellow Laminate, and Lime Green T-Mold Edge and Bookbox)



Adj. Ht.
 1100WS - Standard Desk
 (Shown in Wood Stone Light Oak top)



Fix. Ht.
 1150EE2 - Standard Desk



1100UHP - Standard Desk
 (Shown in **NEW** Standard Hard Plastic Driftwood, and Aqua Bookbox)



1100U - Standard Desk
 (Shown with Zed Cantilever Chair with Powder Coated Gray Frame)

TOP

Work Surface: 430 Sq. Inches

Desktop: 5/8" thick particleboard core, 24" x 18"

Bookbox: Heavy-Duty Propylene with Front Lip
 21"W x 17"D x 4 1/2"H. Color Bookbox Available

FRAME

U-Brace (U): 3/4" 18-Gauge Steel Welded To All Four Legs For Extra Support

Adj. Ht. Desk

Upper Legs: Chrome-Plated 1 1/8" Round 18-Gauge Steel

Insert Legs: 1" 18-Gauge with Two Self-Locking Screws

Height Adjustable: Legs Adjust In 1" Increments

Fix. Ht. Desk

Legs: Chrome-Plated 1 1/8" Round 18-Gauge Steel

Glides: One Height Adjustable, all four are self-leveling with Nickel Plated Casing Nylon Inserts.

HIGH PRESSURE LAMINATE EDGE FINISH



T-Mold
 Standard



X-Strong
 Optional



PVC 3mm
 Optional

Optional Items: Glide Caps (Felt, Rubber and Steel).

Unitized Frame



U-Brace
 Welds

2 Screw
 Adjustable Leg

Standard Series – School Desk with Metal Bookbox



Adj. Ht.
I200U - Standard Desk with U-Brace
(Show in New Standard Stop Red Laminate)



Adjustable height and choice of desktops ensure comfort, while the steel bookbox with pencil tray offers ample storage. The unitized frame provides durability and stability.





Adj. Ht.
1200U - Standard Desk with U-Brace



Fix. Ht.
1250 - Standard Desk



Fix. Ht.
1250 - Standard Desk
(Shown with Zed Cantilever Chair
in Powdered Black Frame)



Adj. Ht.
1200U - Standard Desk with U-Brace

TOP

Work Surface: 430 Sq. Inches

Desktop: 5/8" thick particleboard core, 24" x 18"

Standard Bookbox: Open Front Powder-Coated 20-Gauge Steel 21"W x 17"D x 4 1/2"H

FRAME

U-Brace (U): 3/4" 18-Gauge Steel Welded To All Four Legs For Extra Support

Adj. Ht. Desk

Upper Legs: Chrome-Plated 1 1/8" Round 18-Gauge Steel

Insert Legs: 1" 18-Gauge with Two Self-Locking Screws

Height Adjustable: Legs Adjust In 1" Increments

Fix. Ht. Desk

Legs: Chrome-Plated 1 1/8" Round 18-Gauge Steel

Glides: One Height Adjustable, all four are self-leveling with Nickel Plated Casing Nylon Inserts

HIGH PRESSURE LAMINATE EDGE FINISH



T-Mold
Standard



X-Strong
Optional



PVC 3mm
Optional

Optional Items: Glide Caps (Felt, Rubber and Steel).

Unitized Frame



Screws on
Adjustable Leg



Pencil Groove

Riveted Bookbox



1400U - Adj. Writing Desk with U-Brace
(Shown in custom laminate Formica Matrix Blue #8795)



Adjustable height and desktop options offer comfort for every student. The open-view storage keeps essentials organized, while the unitized frame ensures strength and stability.





1300U - Open View Standard Desk with Bookbasket & U-Brace



1400U - Adj. Writing Desk with U-Brace



1800UHP - ADA Standard Desk with U-Brace



TOP

Work Surface: 430 Sq. Inches

ADA Work Surface: 520 Sq. Inch

Desktop: 5/8" thick particleboard core, 24" x 18"
Woodstones Desktops only available on the 1300 & 1400 series.

Bookbasket: 8-Gauge Steel 19"W x 14"D x 5"H

FRAME

U-Brace (U): 3/4" 18-Gauge Steel Welded To All Four Legs For Extra Support

Adj. Ht. Desk

Upper Legs: Chrome-Plated 1 1/8" Round 18-Gauge Steel

Insert Legs: 1" 18-Gauge with Two Self-Locking Screws

Height Adjustable: Legs Adjust In 1" Increments

Fix. Ht. Desk

Legs: Chrome-Plated 1 1/8" Round 18-Gauge Steel

ADA Option Available: Wider Frame And A Higher Top To Accommodate A Wheelchair & U-Brace is Standard For Added Stability.

ADA 1800UHP - Only available in Beige, Gray Nebula, Light Gray and Wild Cherry.

Glides: One Height Adjustable, all four are self-leveling with Nickel Plated Casing Nylon Inserts

HIGH PRESSURE LAMINATE EDGE FINISH



T-Mold
Standard



X-Strong
Optional



PVC 3mm
Optional

Optional Items: Glide Caps (Felt, Rubber and Steel).



Bookbasket Construction & Underside of Desk



Full-Contact Welds



Adjustable-height legs provide comfort, while versatile bookboxes accommodate various classroom layouts. The double desk fosters collaboration or independent work, supported by a strong, self-supporting unitized frame.



2759 - Fix. Ht Illustration V2 Double Desk
(Shown in custom laminate Formica Silver Oak Herringbone #9311)



1550 - T-Leg Double Desk



1650 - Activity-Leg Double Desk



2759 - Fix. Ht Illustration V2 Double Desk



2750 - Adj. Ht Illustration V2 Double Desk

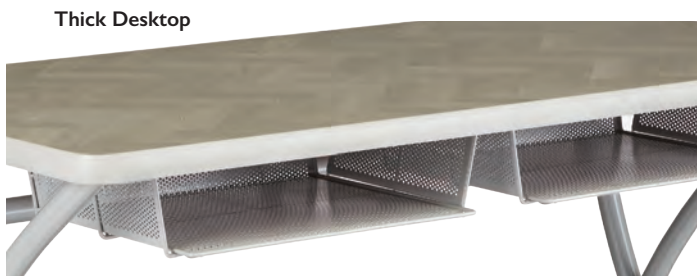

Thick Desktop

Spacious Bookboxes

TOP

Work Surface: 1,152" Sq. Inches

Desktop: 1½" Thick High-Pressure Laminate

FRAME

T-Leg Double Desk

Stretcher Bar: 16-Gauge Powder-Coated Rectangular Tube Welded 1¼"W × 2¼"D with 15-Gauge Angle Iron Support

Upper Legs: 16-Gauge Powder-Coated Rectangular Tubing 1½"W × 2¼"D

Insert Legs: 16-Gauge Chrome-Plated Rectangular Tubing 1"W × 2"D with Three Self-Locking Screws

Glides: Self-Adjusting Nickel-Plated Casing with Nylon Inserts

Activity-Leg Double Desk

Upper Legs: 1½" Outer-Diameter Powder-Coated Tubular Steel

Insert Legs: 1" Outer-Diameter 16-Gauge Chrome-Plated Tubular Steel with Self-Locking Screws

Height Adjustable: Legs Adjust In 1" Increments

Glides: Self-Adjusting Nickel-Plated Casing with Nylon Inserts

Illustration V2 Double Desk

1" Steel Tube: 12-Gauge Steel, Welded At 90° Angle

Stretcher Bar: 1¼" Diameter, 18-Gauge

Fix. Ht Desk Frame: Two 1¼" Diameter Tubes 16-Gauge Steel

Adj. Ht Desk Frame: Two 1½" Diameter, 16-Gauge Steel Chrome Legs

Height Adjustable: 27½"-31½"

Casters/Glides: Compatible with Ht. Adj. Glides (Standard) or Casters (Optional)

HIGH PRESSURE LAMINATE EDGE FINISH



Optional Items: Backpack Hook, Casters, and Glides.

Matching Options



Illustration V2 Desk
See page 58-59



T-Leg Desk
See page 60-61



S4 Stacking Series – School Desk

Desk Ht."	W x D"	Model
High Pressure Laminate		
29 1/4"	29 x 20"	4429
21-33	29 x 20	4400A



Junction – School Desk

Standard	Toddler	Standing Ht.
(23-32" H)	(17-22" H)	(26-42" H)
Right Hand (35.1 W x 21.7" D)		
5300	5300S	5300SH
5300EE	5300EES	—
Left Hand (35.1 W x 21.7" D)		
5300-LH	5300S-LH	5300SH-LH
5300EE-LH	5300EES-LH	—

Optional Items: Hard and Soft Casters, Mesh Bookbox, Backpack Hook.



Synergy – School Desk

Standard	Toddler	Standing Ht.
(23-32" H)	(17-22" H)	(26-42" H)
Synergy (29 W x 36" D)		
5200	5200S	5200SH
5200EE	5200EES	—

Optional Items: Hard and Soft Casters, Mesh Bookbox, Backpack Hook.



Petal Series – School Desk

Standard	Toddler	Standing Ht.
(23-32"H)	(17-22"H)	(26-42"H)
Petal (32 1/2 W x 20 1/4" D)		
1900	1900S	1900SH
1900EE	1900EES	—
1900HP	1900HPS	1900HPSH
1900HPEE	1900HPEES	—
Junior Petal (30 3/4 W x 21" D)		
1950	1950S	1950SH
1950EE	1950EES	—
1950HP	1950HPS	1950HPSH
1950HPEE	1950HPEES	—

Optional Items: Backpack hook, Casters, Mesh Bookbox.

Hard-Plastic Desktop Colors: Not Available in Beige.



Synco Series – School Desk

Standard Ht.	Model
26-33"	5400

Optional Items: Bookboxes, Casters, Grommets, Hooks and Power.



Innovation Series – School Desk

Standard	Standing Ht.
(23-33" H)	(31-43" H)
Innovation Desk (36 W x 28" D)	
2000	2000SH
2000HP	2000HPSH

Optional Items: Backpack Hook, Glide Inserts (Nylon, Felt, Steel or Rubber), Glide Insert Replacements, Mesh Bookbox, Wire Bookrack, and Power Post.

Hard-Plastic Desktop Colors: Not Available in Light Gray and Beige.

Traditionally Modern



Surge Series – School Desk

W x D"	Standard Ht.	
	Adj. 26 1/2-38 1/2" H	Adj. 29-42" H
High Pressure Laminate		
26 1/2 x 24"	1626	1629
Hard-Plastic		
26 3/4 x 19 1/2"	1626HP	1629HP
WoodStone		
26 3/4 x 19 1/2"	1626WS	1629WS

Optional Items: Backpack Hook, Cup Holder, Mesh Bookbox, Rubber Glides, and Tote Bin.



Illustration V2 Series – School Desk

W x D"	Standard Ht.		
	Adj. 26-30" H	Fix. 26" H	Fix. 29" H
High Pressure Laminate			
27 3/4 x 19 1/2"	2700	2726	2729
27 3/4 x 19 1/2"	2700WBB	2726WBB	2729WBB
Hard-Plastic			
26 3/4 x 19 1/2"	2700HP	2726HP	2729HP
26 3/4 x 19 1/2"	2700HPWBB	2726HPWBB	2729HPWBB
WoodStone			
26 3/4 x 19 1/2"	2700WS	2726WS	2729WS
26 3/4 x 19 1/2"	2700WSWBB	2726WSWBB	2729WSWBB

Optional Items: Backpack Hook, Bookbox, Modesty Panel, and Rubber Glides.

Edge Finish & Color Options

Junction, Synergy & Petal Series

Standard: Hydraulically inserted T-Mold edge banding in Black or Gray.

Optional Educational Edge (EE): Color coordinated edge banding and legs are available for Standard and Toddler Height. Standing Height legs are only available in Black or Gray.

Optional X-Strong Finish and PVC 3mm Finish: Are available in all standard and Educational Edge colors.

S4 Series, Synco, Innovation Series, Surge Series & Illustration V2 Series

Standard: Hydraulically inserted T-Mold edge banding in Black or Gray.

Optional: Colored T-Mold edge.

Optional X-Strong Finish and PVC 3mm Finish: Are available in all standard and colored edge options.



T-Leg Series – School Desk

W x D"	Standard Ht.
	22½-32½" H

High Pressure Laminate

27¾ x 19½"	1500
27¾ x 19½"	1500WBB

Hard-Plastic

26¾ x 19½"	1500HP
26¾ x 19½"	1500HPWBB

WoodStone

26¾ x 19½"	1500WS
26¾ x 19½"	1500WSWBB

Optional Items: Casters, Mesh Bookbox, and Rubber Glides.

T-Leg Desks Color: Light Gray or Black Frame Finish



Standard Series – School Desk w/ Plastic Bookbox

W x D"	Adj. 24-31" H	Fix. 29½" H
--------	---------------	-------------

High Pressure Laminate

24 x 18½"	1100	1150
24 x 18½"	1100U	1150U

Hard-Plastic

24 x 18½"	1100HP	1150HP
24 x 18½"	1100UHP	1150UHP

WoodStone

24 x 18½"	1100WS	1150WS
24 x 18½"	1100UWS	1150UWS

Optional Items: Glide Caps (Felt, Rubber and Steel).



Standard Series – School Desk w/ Metal Bookbox

W x D"	Adj. 24-31" H	Fix. 29½" H
--------	---------------	-------------

High Pressure Laminate

24 x 18½"	1200	1250
24 x 18½"	1200U	1250U

Hard-Plastic

24 x 18½"	1200HP	1250HP
24 x 18½"	1200UHP	1250UHP

WoodStone

24 x 18½"	1200WS	1250WS
24 x 18½"	1200UWS	1250UWS

Optional Items: Glide Caps (Felt, Rubber and Steel).

Standard Series – Open View/Writing School Desk



W x D"	Adj.	Fix.
	Adj. (24-31" H)	(29½" H)

High Pressure Laminate w/ bookbasket

24 x 18½"	1300	1350
24 x 18½"	1300U	1350U

High Pressure Laminate w/o bookbasket

24 x 18½"	1400U	1450U
-----------	-------	-------

Hard-Plastic w/ bookbasket

24 x 18½"	1300HP	1350HP
24 x 18½"	1300UHP	1350UHP

Hard-Plastic w/o bookbasket

24 x 18½"	1400UHP	1450UHP
-----------	---------	---------

WoodStone w/ bookbasket

24 x 18½"	1300WS	1350WS
24 x 18½"	1300UWS	1350UWS

WoodStone w/o bookbasket

24 x 18½"	1400UWS	1450UWS
-----------	---------	---------



Standard Series – Wheelchair School Desk

W x D"	ADA**
	Adj. (26-34" H)

High Pressure Laminate

36 x 20"	1800U
----------	-------

Hard-Plastic

36 x 20"	1800UHP
----------	---------



Optional Items: Glide Caps (Felt, Rubber and Steel).

**ADA 1800UHP - Only available in Beige, Gray Nebula, Light Gray and Wild Cherry.

Double Desks



Table Ht."	W x D"	Model
------------	--------	-------

T-Leg Series Double Desk

22½-32½"	48 x 24"	1550
----------	----------	------

Activity Series Double Desk

23-32"	48 x 24"	1650
--------	----------	------

Illustration V2 Series Double Desk

27½-31½"	48 x 24"	2750
29"	48 x 24"	2759

Optional Items: Backpack Hook, Casters, and Glides. (Casters for T-Leg & Illustration V2 Series Double Desk only).

T-Leg Double Desk are not available with a Light Gray or Black Frame Finish.

Bookboxes are standard on all Double Desk. See all standard bookboxes on page 149

Edge Finish & Color Options

T-Leg Series, Standard Series & Double Desks

Standard: Hydraulically inserted T-Mold edge banding in Black or Gray.

Optional: Colored T-Mold edge.

Optional X-Strong Finish and PVC 3mm Finish: Are available in all standard and colored edge options.

Standard Series School Desk w/ Plastic Bookbox

Standard: Hydraulically inserted T-Mold edge banding in Black or Gray with black bookbox.

Optional: Colored T-Mold edge.

Optional X-Strong Finish and PVC 3mm Finish: Are available in all standard and colored edge options.

Optional Colored Bookbox: Is available for HPL, Hard-Plastic and Woodstone.

Unity Study – School Combo Desk



Designed for collaboration, this mobile desk features locking casters, accessible book storage, and a durable surface.

Easily switch between group and solo work with secure, one-handed adjustments.



2958C - 18" Unity Study Combo Desk
(Shown in custom laminate Formica Weathered Beamwood #6410)



2958C - 18" Unity Study Combo Desk
w/ Back Casters

SEAT

Shell: One-Piece, Color-Impregnated Polypropylene Molded Plastic with Built-In Carry Handle

Back: Lumbar Support

DESK

Work Surface: 507 Sq. Inches

Desktop: 5/8" Thick, 32 1/2"W × 20 1/4"D

FRAME

Bookbasket*: Chrome-Plated 1/4" Rod Steel
14 1/2"W × 12"D × 8"H

Seat & Desktop Supports: 1 1/8" Round 14-Gauge Steel

Front Legs: Chrome-Plated 1 1/8" Round 16-Gauge Steel

Front Glides: Self-Adjusting Nylon

Back Legs: Chrome-Plated, 1 1/8" Round 18-Gauge Steel

Back Casters: Double Hooded 2" Self-Braking Casters

*Bookbasket on combo is standard, but can be requested without one at the time of ordering. Bookbasket must be installed by manufacturer.

Optional Items: Glide Caps (Felt, Rubber and Steel), and Hard & Soft Casters.

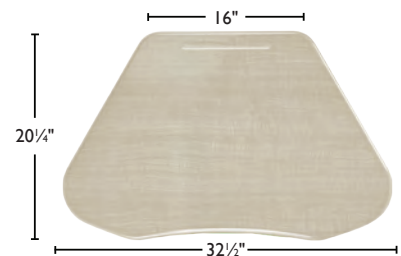

Pod of Four

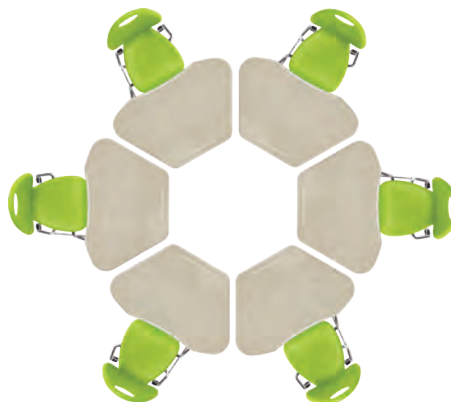

Pod of Six



Back with Ribs



2918WS - 18" Inspiration Combo Desk



Inspirational design with a curved WoodStone desktop, supportive flex-back, heavy-gauge round tubing, and 120° memory swivel seat for easy entry and exit. Built for strength and comfort.





2914WS - 14" Inspiration Combo Desk



2918WSSB - Sled Base Combo Desk



Curved Desktop and Support Brace



X-Plus Offers Additional 1" Clearance from Seat to Desktop



Full-Contact Welds



19 1/2"

27"

SEAT

Shell: Injection-Molded Polypropylene Plastic with Built-In Carry Handle

Back: Lumbar Support

DESK

Work Surface: 432 Sq. Inches

Desktop: Arc-Shaped Woodstone with Built-In Pencil Groove 3/8" Thick, 27"W × 19 1/2"D

FRAME

Bookbasket*: Chrome-Plated 1/4" Rod Steel 14 1/2"W × 12"D × 8"H

Standard

Seat & Desktop Supports: 1 1/8" Round 14-Gauge Steel

Front Legs: Chrome-Plated 1 1/8" Round 16-Gauge Steel

Back Legs: Chrome-Plated, 1 1/8" Round 18-Gauge Steel

Wraparound Brace: 3/4" Round 18-Gauge Steel

Boots: Color-Impregnated Polypropylene Plastic

Glides: Self-Adjusting Nylon

Sled Base

Frame: 1 1/4" 14-Gauge

Optional Glides: Rubber screw-in glides add on item

X-Plus (X): Larger shell and Frame for added weight capacity available.

*Bookbasket on combo is standard, but can be requested without one at the time of ordering. Bookbasket must be installed by manufacturer.

Optional Items: Glide Caps (Felt, Rubber and Steel) and Rubber screw-in glides for Sled Base combo.



Timeless design with a curved, vented back, waterfall seat, and 400+ sq. in. desktop. Features a built-in bookbasket, pencil groove, and durable steel supports for comfort, stability, and organization.



2218 - 18" Classic Combo Desk
(Shown with Driftwood top and custom Purple edge banding)



2214 - 14" Classic Combo Desk
(Shown with Driftwood top and custom Aqua edge banding)



2618 - Sled Base Combo Desk

SEAT

Shell: Injection-Molded Polypropylene Plastic with Waterfall Front and Vented Back

Back Support: 16-gauge Steel Built-In Supports

DESK

Work Surface: 430 Sq. Inches

Desktop: 5/8" Thick with PVC Edge Banding 24" x 18 1/2"

FRAME

Bookbasket*: Chrome-Plated 1/4" Rod Steel
14 1/2"W x 12"D x 8"H

Standard

Seat and Desktop Supports: 1 1/8" Round 14-Gauge Steel

Front Legs: Chrome-plated, 1 1/8" round 16-gauge steel

Back Legs: Chrome-Plated, 1 1/8" Round 18-Gauge Steel

Glides: Self-Adjusting Nylon

Sled Base

Frame: Chrome-Plated, 1 1/4" Round, 14-Gauge. Ease of entry from either side, perfect for carpeted areas, extra strong frame.

Optional Glides: Rubber screw-in glides add on item

*Bookbasket on combo is standard, but can be requested without one at the time of ordering. Bookbasket must be installed by manufacturer.

Optional Items: Glide Caps (Felt, Rubber and Steel) and Rubber screw-in glides for Sled Base combo.



14-Gauge Underseat Steel



Steel Back Supports





2518 - 18" Hard-Plastic Combo Desk

“Featuring a contoured seat, posture-perfect back, and durable one-piece construction, this combo desk offers strength, comfort, and mobility while promoting teacher-student interaction and classroom organization.”



2518 - 18" Hard-Plastic Combo Desk



2628 - 18" Sled Base Combo Desk
(Shown in custom laminate Wilsonart Ocean #D502)

SEAT

Back: 3/8" Thick Hard-Plastic 13 1/8" W x 6 3/8" L

Seat: 3/8" Thick

Back Support: 3/4" Round,
16", 18" & 19" - 14-Gauge Steel
14" Combos - 16-Gauge Steel

DESK

Work Surface: 430 Sq. Inches

Desktop: 3/8" Thick with PVC Edge Banding
24" x 18 1/2"

FRAME

Bookbasket*: Chrome-Plated 1/4" Rod Steel
14 1/2" W x 12" D x 8" H

Standard

Seat and Desktop Supports: Chrome-Plated 1 1/8" Round 14-Gauge Steel

Front Legs: Chrome-Plated 1 1/8" Round 16-Gauge Steel

Back Legs: Chrome-Plated, 1 1/8" Round 18-Gauge

Glides: Self-Adjusting Nylon

Sled Base

Frame: Chrome-Plated, 1 1/4" Round, 14-Gauge. Ease of entry from either side, perfect for carpeted areas, extra strong frame.

Optional Glides: Rubber screw-in glides add on item

*Bookbasket on combo is standard, but can be requested without one at the time of ordering. Bookbasket must be installed by manufacturer.

Optional Items: Glide Caps (Felt, Rubber and Steel) and Rubber screw-in glides for Sled Base combo.



Bookbasket

Optional Sled Base Glide



Full-Contact Welds

Under Desktop Construction





Built for durability, this combo desk features a hard-plastic seat, posture-perfect back, spacious desktop, and integrated bookbasket. Its braced frame design ensures strength while keeping classrooms organized and efficient.



2538WS - Double Braced Combo Desk with Arc-Shaped WoodStone Desktop



2538WS - Double Braced Combo Desk with Arc-Shaped WoodStone Desktop



2528HP - Single Braced Combo Desk with Rectangular Hard-Plastic Desktop



2528JHP - Single Braced Combo Desk with Jumbo Tablet-Arm Hard-Plastic Desktop



Full-Contact Welds

Bookbasket

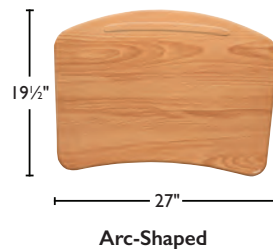

Arc-Shaped

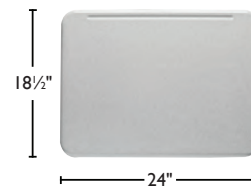

Rectangular

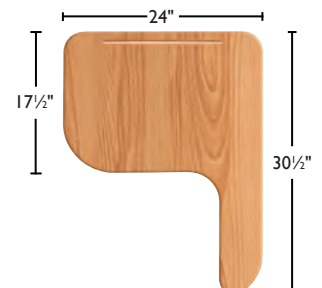

Jumbo Tablet-Arm

SEAT

Back: 5/8" Thick Hard-Plastic 13 1/8" W × 6 3/8" L

Seat: 5/8" Thick

Back Support: 3/4" Round
16", 18" & 19" - 14-Gauge Steel
14" Combos - 16-Gauge Steel

DESK

Arc-Shaped Work Surface: 432 Sq. Inches.

Desktop: Woodstone Desktop with Built-In Pencil Groove 5/8" Thick, 27"W × 19 1/2"D

Rectangular Work Surface: 430 Sq. Inches

Desktop: 5/8" Thick with Pencil Groove, 24"W × 18 1/2"D.
Various Right & Left-Handed Options.
See pages 84-87 for details.

Jumbo Tablet-Arm Work Surface: 470 Sq. Inches

Desktop: 5/8" Thick with Pencil Groove, 24"W × 17 1/2"D.

FRAME

Bookbasket*: Chrome-Plated 1/4" Rod Steel
14 1/2"W × 12"D × 8"H

Seat and Desktop Supports: Chrome-Plated 1 1/8" Round, 14-Gauge Steel

Double Braced Frame (253): Includes 8 gauge wrap around tubing for added strength and support. Double Braced is available on Hard Plastic only.

Front Legs: Chrome-Plated 1 1/8" Round, 16-Gauge Steel

Back Legs: Chrome-Plated 1 1/8" Round, 18-Gauge Steel

Glides: Self-Adjusting Nylon

*Bookbasket on combo is standard, but can be requested without one at the time of ordering. Bookbasket must be installed by manufacturer.

Optional Items: Glide Caps (Felt, Rubber and Steel).



3218HP - 18" Classic Tablet-Arm Combo Desk



Comfortable tablet-arm chairs with a contoured seat, posture-perfect back, and supportive desktop. Built to last with 18-gauge steel legs, ideal for testing, light use, and quick turnover spaces.





3218HP - 18" Classic Tablet-Arm Combo Desk



3518HP - 18" Right Handed Hard Plastic Tablet-Arm Combo Desk

SEAT

Classic

Shell: Injection-Molded Polypropylene Plastic with Waterfall Front and Vented Back

Back Support: 16-gauge Steel Built-In Supports

Hard Plastic

Back: 5/8" Thick Hard-Plastic 13 3/8" W × 6 3/8" L

Seat: 5/8" Thick

Back Supports: 3/4" Round, 14-Gauge Chrome-Plated Steel

DESK

Desktop: 5/8" Thick, 19" W × 26" D with Self-Edge & Pencil Groove

FRAME

Bookbasket*: Chrome-Plated 1/4" Rod Steel. 14 1/2" W × 12" D × 8" H

Classic

Seat & Desktop Frame: Chrome-Plated 1 1/8" Round 16-Gauge Steel

Underseat Brackets: Two 14-Gauge Steel

Glides: Self-Adjusting Nylon

Hard Plastic

Desktop Supports: Chrome-Plated 7/8" Round, 14-Gauge Steel

Legs: 1" Round 16-Gauge Chrome-Plated Steel

Glides: Self-Adjusting Nickel-Plated Casing With Nylon Inserts

*Bookbasket on combo is standard, but can be requested without one at the time of ordering. Bookbasket must be installed by manufacturer.

Optional Items: Glide Caps (Felt, Rubber and Steel).



Underseat Steel Structure



Bookbasket

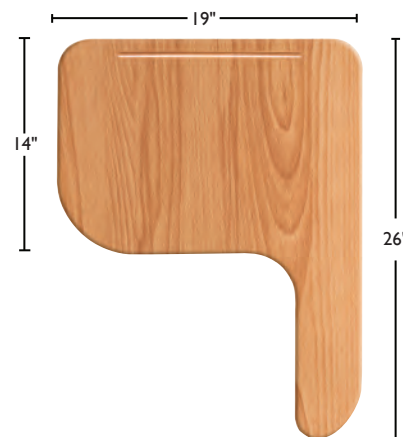

Unity Study – School Combo Desk



Seat Ht."	Seat W × D"	Overall W × H × D"	Model
High Pressure Laminate			
18"	17¾ × 16"	32½ × 29 × 38½"	2958
18"	17¾ × 16"	32½ × 29 × 38½"	2958C
Hard Plastic			
18"	17¾ × 16"	32½ × 29 × 38½"	2958HP
18"	17¾ × 16"	32½ × 29 × 38½"	2958CHP

Optional Items: Glide Caps (Felt, Rubber and Steel), and Hard & Soft Casters.

Back Casters can be replaced with glides.

Inspiration Series – School Combo Desk



Seat Ht."	Seat W × D"	Overall W × H × D"	Model
WoodStone			
14"	12¼ × 12"	27 × 24¾ × 34"	2914WS
16"	16 × 16"	27 × 31½ × 37"	2916WS
18"	17¾ × 16"	27 × 33½ × 37"	2918WS
18"	17¾ × 16"	27 × 33½ × 37"	2918XWS
19"	17¾ × 16"	27 × 34½ × 37"	2919WS
19"	17¾ × 16"	27 × 34½ × 37"	2919XWS



Seat Ht."	Seat W × D"	Overall W × H × D"	Model
Sled Base			
18"	17¾ × 16"	27 × 33½ × 38"	2918WSSB

X-Plus (X): Larger shell and Frame for added weight capacity available.

Optional Items: Glide Caps (Felt, Rubber and Steel) and Rubber screw-in glides for Sled Base combo.

About Bookbasket

Combo Bookbasket: Bookbasket on combo is standard, but can be requested without one at the time of ordering. Bookbasket must be installed by manufacturer.

Note the color needed at the time of ordering • All heights listed are within ¼" variants.

Classic Series – School Combo Desk



Seat Ht."	Seat W × D"	Overall W × H × D"	Right Hand	Left Hand
High Pressure Laminate				
14"	13 × 12"	24 × 27¼ × 34"	2214	2214LH
16	16¼ × 15	24 × 29½ × 33	2216	2216LH
18	16¼ × 15	24 × 31½ × 33	2218	2218LH
19	16¼ × 15	24 × 33 × 36	2219	2219LH
Hard-Plastic				
14"	13 × 12"	24 × 27¼ × 34"	2214HP	2214HP-LH
16	16¼ × 15	24 × 29½ × 33	2216HP	2216HP-LH
18	16¼ × 15	24 × 31½ × 33	2218HP	2218HP-LH
19	16¼ × 15	24 × 33 × 36	2219HP	2219HP-LH
WoodStone				
14"	13 × 12"	24 × 27¼ × 34"	2214WS	2214WS-LH
16	16¼ × 15	24 × 29½ × 33	2216WS	2216WS-LH
18	16¼ × 15	24 × 31½ × 33	2218WS	2218WS-LH
19	16¼ × 15	24 × 33 × 36	2219WS	2219WS-LH



Seat Ht."	Seat W × D"	Overall W × H × D"	Model
Sled Base			
18"	16¼ × 15"	27 × 33¼ × 38"	2618
18	16¼ × 15	27 × 33¼ × 38	2618HP
18	16¼ × 15	27 × 33¼ × 38	2618WS

Optional Items: Glide Caps (Felt, Rubber and Steel) and Rubber screw-in glides for Sled Base combo.

Hard-Plastic Series – School Combo Desk



Seat Ht."	Seat W × D"	Overall W × H × D"	Right Hand	Left Hand
High Pressure Laminate				
14"	13½ × 13"	24 × 27½ × 33"	2514	2514-LH
16	15¾ × 15	24 × 29½ × 34	2516	2516-LH
18	15¾ × 15	24 × 31¼ × 34	2518	2518-LH
19	15¾ × 15	24 × 32¾ × 36	2519	2519-LH
Hard Plastic				
14"	13½ × 13"	24 × 27½ × 33"	2514HP	2514HP-LH
16	15¾ × 15	24 × 29½ × 34	2516HP	2516HP-LH
18	15¾ × 15	24 × 31¼ × 34	2518HP	2518HP-LH
19	15¾ × 15	24 × 32¾ × 36	2519HP	2519HP-LH
WoodStone				
14"	13½ × 13"	24 × 27½ × 33"	2514WS	2514WS-LH
16	15¾ × 15	24 × 29½ × 34	2516WS	2516WS-LH
18	15¾ × 15	24 × 31¼ × 34	2518WS	2518WS-LH
19	15¾ × 15	24 × 32¾ × 36	2519WS	2519WS-LH



Seat Ht."	Seat W × D"	Overall W × H × D"	Model
Sled Base			
18"	15¾ × 15"	24 × 32 × 35"	2628
18	15¾ × 15	24 × 32 × 35	2628HP
18	15¾ × 15	24 × 32 × 35	2628WS

Optional Items: Glide Caps (Felt, Rubber and Steel) and Rubber screw-in glides for Sled Base combo.

Note the color needed at the time of ordering • All heights listed are within ¾" variants.

Hard-Plastic Series – Braced School Combo Desk



Seat Ht."	Seat W × D"	Overall W × H × D"	Right Hand	Left Hand
High-Pressure Laminate				
14"	13½ × 13"	24 × 27½ × 33"	2524	2524-LH
16	15¼ × 15	24 × 29½ × 34	2526	2526-LH
18	15¼ × 15	24 × 31¼ × 34	2528	2528-LH
19	15¼ × 15	24 × 32¾ × 34	2529	2529-LH
Hard-Plastic				
14"	13½ × 13"	24 × 27½ × 33"	2524HP	2524HP-LH
16	15¼ × 15	24 × 29½ × 34	2526HP	2526HP-LH
18	15¼ × 15	24 × 31¼ × 34	2528HP	2528HP-LH
19	15¼ × 15	24 × 32¾ × 36	2529HP	2529HP-LH
WoodStone				
14"	13½ × 13"	24 × 27½ × 33"	2524WS	2524WS-LH
16	15¼ × 15	24 × 29½ × 34	2526WS	2526WS-LH
18	15¼ × 15	24 × 31¼ × 34	2528WS	2528WS-LH
19	15¼ × 15	24 × 32¾ × 36	2529WS	2529WS-LH



Seat Ht."	Seat W × D"	Overall W × H × D"	Right Hand
Hard-Plastic Tablet-Arm			
14"	13½ × 13"	24 × 27½ × 33"	2524JHP
16	15¼ × 15	24 × 29½ × 34	2526JHP
18	15¼ × 15	24 × 31¼ × 34	2528JHP
19	15¼ × 15	24 × 32¾ × 36	2529JHP
WoodStone Tablet-Arm			
14"	13½ × 13"	24 × 27½ × 33"	2524JWS
16	15¼ × 15	24 × 29½ × 34	2526JWS
18	15¼ × 15	24 × 31¼ × 34	2528JWS
19	15¼ × 15	24 × 32¾ × 36	2529JWS



Hard-Plastic Series – Double Braced School Combo Desk

Seat Ht."	Seat W × D"	Overall W × H × D"	Right Hand
WoodStone			
18	15¼ × 15	24 × 31¼ × 34	2538WS
Hard Plastic			
18	15¼ × 15	24 × 31¼ × 34	2538HP

Optional Items: Glide Caps (Felt, Rubber and Steel).

About Bookbasket

Combo Bookbasket: Bookbasket on combo is standard, but can be requested without one at the time of ordering. Bookbasket must be installed by manufacturer.

Note the color needed at the time of ordering • All heights listed are within ¼" variants.

Classic Series – School Tablet-Arm Combo



Seat Ht."	Seat W × D"	Overall W × H × D"	Right Hand
WoodStone			
16"	16¼ × 15"	21 × 29 × 31"	3216WS
18	16¼ × 15	21 × 31½ × 31	3218WS
19	16¼ × 15	21 × 31½ × 32	3219WS
Hard-Plastic			
16"	16¼ × 15"	21 × 29 × 31"	3216HP
18	16¼ × 15	21 × 31½ × 32	3218HP
19	16¼ × 15	21 × 31½ × 32	3219HP

Hard Plastic Series – School Tablet-Arm Combo



Seat Ht."	Seat W × D"	Overall W × H × D"	Right Hand
WoodStone			
15¾"	15¾ × 15"	20 × 28½ × 31"	3516WS
17¾	15¾ × 15	20 × 30½ × 31	3518WS
19	15¾ × 15	20 × 31½ × 31	3519WS
Hard-Plastic			
15¾"	15¾ × 15"	20 × 28½ × 31"	3516HP
17¾	15¾ × 15	20 × 30½ × 31	3518HP
19	15¾ × 15	20 × 31½ × 31	3519HP

Optional Items: Glide Caps (Felt, Rubber and Steel).



Note the color needed at the time of ordering • All heights listed are within ¾" variants.



Gentle contours and customizable glides or casters offer adaptable height, ample knee space, and full desktop use. Fits seamlessly within tabletops, enhancing any desk or table setup.



Adj. Standard Ht
FL-3672KI - Kidney Table
(Shown in New Standard Laminate Chambray Fabric
and PVC 3mm Edge in Navy)



FL-2448 - Rectangle Table



FL-2448TR - Trapezoid Table



FL-6060FL - Flower Table



FL-4848CV - Clover Table



FL-4242SC - Squircle Table



FL-36RD - Round Table

TOP

Tabletop: 1 1/8" thick fiberboard high pressure laminate surface.

FRAME

Stretcher Bar: Underside for extra support. 60" tables and above.

Upper Legs: Powder-coated 1.5" diameter: 16 gauge.

Insert Legs: Powder-coated 1.35" diameter: 16 gauge with two self-locking screws.

Height Adjustable: Adjusts 26-33" with glides. Legs adjust in 1" increments.

Wheelbarrow Option: Available.

Casters/Glides: Ht. Adj. glides (standard) or casters (optional)

HIGH PRESSURE LAMINATE EDGE FINISH



Optional Items: Bookboxes, Casters, Grommets, Hooks and Power.



Height Adjustable Glide



NEW Standard Laminate Cassis with Purple T-Mold Edge

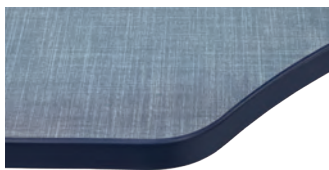

NEW Standard Laminate Chambray Fabric with Navy PVC 3mm Edge



Underside Frame



Adjustable Legs Compatible with Casters or Glides

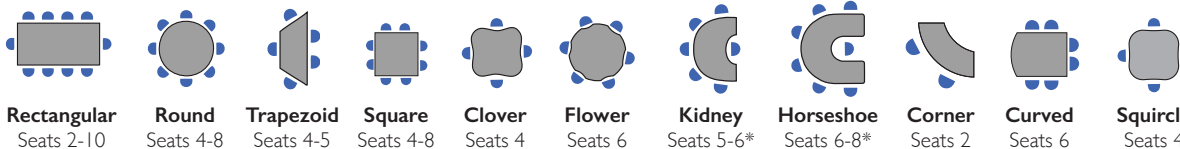

Seat qty. varies depending on dimensions.
*Plus 1 teacher seat

Hercules Series – Group-Study and Activity Table



Signature Hercules legs are strong and aesthetically pleasing for all settings. Customizable with 14 leg/edge colors and 40 total standard laminate top options.



Standard Ht.
HL-2448 - Rectangle Table
(Shown in New Standard Laminate Chrome Yellow, and Zed Cantilever Chairs)

Hercules Series – Group-Study and Activity Table

Classroom Table



Standard Ht.
HL-2448 - **Rectangle Table**
(Shown in New Standard Laminate Graphite,
and Primary Green X-Strong Edge)



Toddler Ht.
HL-4254CU - **Curved Table**
(Shown in Sky Rise Laminate)



Standard Ht.
HL-3672-KI - **Kidney Table**
(Shown in Fusion Maple Laminate)



Standard Ht.
HL-3636SC - **Squirle Table**
(Shown in New Standard Laminate Stop Red)

TOP

Tabletop: 1 1/8" Thick Fiberboard High Pressure Laminate Surface

FRAME

Stretcher Bar: Underside For Extra Support. 60" Tables And Above

Upper Legs: Powder-Coated 2 1/8" Round 18-Gauge Steel

Insert Legs: Chrome-Plated 2" Round 16-Gauge Steel with Two Self-Locking Screws

Height Adjustable: Legs Adjust In 1" Increments

Wheelbarrow Option: Available on Adj. Ht. Tables only. See pages 108-111 for details.

Height Options: Sushi (12-16"), Toddler (17-22") & Standard (23-32")

Casters/Glides: Compatible with Ht. Adj. Glides (Standard) or Casters (Optional)

HIGH PRESSURE LAMINATE EDGE FINISH



Optional Items: Bookboxes, Casters, and Grommets.



Adjustable Legs Compatible with Casters or Glides



Height Adjustable Glide



New PVC 3mm Edge
(Shown in Aqua)



New X-Strong Edge
(Shown in Tangerine)



Heavy Duty Support Plate



Stretcher Bar

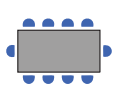

Rectangular
Seats 2-10



Round
Seats 4-8



Trapezoid
Seats 4-5



Kidney
Seats 5-6*



Horseshoe
Seats 6-8*



Square
Seats 4-8



Clover
Seats 4



Flower
Seats 6



Inspiration
Seats 4



Corner
Seats 2



Curved
Seats 6



Squirle
Seats 4



Half Round
Seats 1

Seat qty. varies depending on dimensions.

*Plus 1 teacher seat

Size & Order Info
See pages 108-111

Colors, Guides,
& Accessories
See pages 144-149

Academia
FURNITURE INDUSTRIES
www.academiafurniture.com



HS-3152CD & HS-3052RY -
Chord and Rhythm Configuration
(Shown in Formica Amarena #6907 and
Spectrum Blue #851 with optional Casters)



Harmony tables evoke wave-like tranquility with 4 versatile shapes, durable laminate surfaces, and T-mold edging. Ideal for classrooms, STEM labs, and libraries, with a marker board option for creative collaboration.





Standard Ht.
HS-3052RY - Rhythm



Standard Ht.
HS-3152CD - Chord



Standard Ht.
HS-5252TN - Tone



Standard Ht.
HS-5252ML - Melody



V2N-3052-RY - Harmony Nesting Rhythm Table
(Shown in New Standard Laminate Vibrant Green and Primary Blue X-Strong Edge)



TOP

Tabletop: 1/8" Thick Fiberboard High Pressure Laminate Surface

FRAME

Upper Legs: Powder-Coated 2 1/8" Round 18-Gauge Steel Legs

Insert Legs: Chrome-Plated 2" Round 16-Gauge Steel with Two Self-Locking Screws

Height Adjustable: Legs Adjust In 1" Increments

Casters/Glides: Compatible with Ht. Adj. Glides (Standard) or Casters (Optional)

Nesting Table

Stretcher Bar: 2 Rectangular Steel Bars 1/2" x 3/4". Torsion Bar Connects The Table Top & Leg Frame Allows for a Slow And Safe Close

Lever Mechanism: Spring Loaded Auto-Lock Handle in Open/Closed Positions

Casters/Glides: Compatible with Casters (Standard) or Ht. Adj. Glides (Optional)

Note: Casters add 2-3" to the overall height.

HIGH PRESSURE LAMINATE EDGE FINISH



T-Mold
Standard



X-Strong
Optional



PVC 3mm
Optional

Optional Items: Casters, and Grommets.



Need help configuring in groups?
Request a complimentary puzzle set.

Marker-Board Table Top

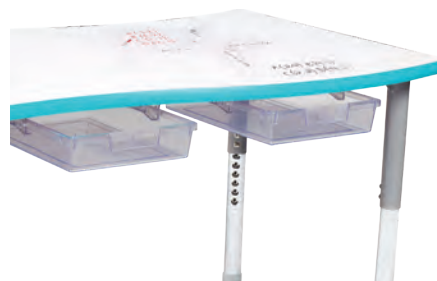

9CRTWD-SLIM TRAY-C
Clear or Crystal Tray



Adjustable Legs Compatible
with Casters or Glides

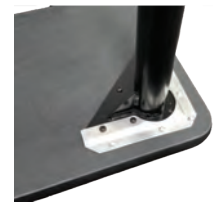

Underside of Table



Hidden Handlebar



Rhythm
Seats 4

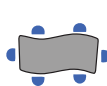

Chord
Seats 6



Tone
Seats 3

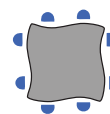

Melody
Seats 8

Seating varies for Rhythm & Chord Nesting Table.



Dura's steel frame and bolted legs ensure unmatched durability. Adjustable or fixed-height legs suit all ages. Available in 11 shapes, standing height, and marker board tops for creative collaboration.



Fix. Standing Ht.
WLSHF-4848CLVR - **Clover Dura Table**
(Shown with X-Strong Edge & Z430 - Zed Café Stool)



Adj. Standard Ht.
WLA-6066HS - **Horseshoe Dura Table**
(Shown with Optional Casters)



Adj. Standard Ht.
WLA-6060FLEE - **Flower Dura Table**



Fix. Standing Ht.
WLSHF-4848CV - **Clover Dura Table**



Adj. Standard Ht.
WLA-2460 - **Rectangle Dura Table**
(Shown with Wheelbarrow Option)



Adj. Standard Ht.
WLA-2460 - **Rectangle Dura Table**



Adj. Standard Ht.
WLA-2448TR - **Trapezoid Dura Table**



Adj. Standard Ht.
WLA-6060AD - **Adam Dura Table**
(Shown with Squirrelle® Active Seating Stool)



Fix. & Adj. Option



PVC 3mm Edge
(Shown in Aqua)



X-Strong Edge
(Shown in Tangerine)



Marker-Board Table Top Option

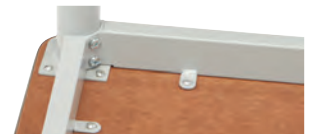

Fully Welded Strong Unitized Frame

TOP

Tabletop: 1/8" Thick Fiberboard High Pressure Laminate Surface

FRAME

Fully Welded, Unitized Frame: 2" x 1" Rectangular 16-Gauge Steel Frame welded to 1 7/8" Round 16-Gauge Steel Legs

Upper Legs: Available in Black or Tungsten Color

Insert Legs: Chrome-Plated 2" Round 16-Gauge Steel

Height Adjustable: Legs Adjust In 1" Increments

Height Options: Available In Four Height Variations

Wheelbarrow Option: Available on Adj. Ht. Tables only. See pages 108-111 for details.

Casters/Glides: Compatible with Ht. Adj. Glides (Standard) or Casters (Optional)

Note: Casters add 2-3" to the overall height.

HIGH PRESSURE LAMINATE EDGE FINISH



T-Mold
Standard



X-Strong
Optional



PVC 3mm
Optional

Optional Items: Casters and Power Port

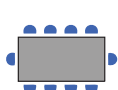

Rectangular
Seats 2-10



Adam
Seats 6



Chad
Seats 6



Round
Seats 4-8



Trapezoid
Seats 4-5



Kidney
Seats 5-6*



Horseshoe
Seats 6-8*



Square
Seats 4-8



Clover
Seats 4



Flower
Seats 6



Squirrelle
Seats 4

Seat qty. varies depending on dimensions.

*Plus 1 teacher seat



Durable tables with a high-pressure laminate top, adjustable powder-coated steel legs, chip-resistant edge banding, and five laminate options. Additional colors available for a customized look.



Standard Ht
AL-2448 - Rectangular Activity Table
(Shown in standard laminate Driftwood)



Standard Ht.
AL-4848CV - Clover Activity Table



Standard Ht.
AL-48HR - Half Round Activity Table



Standard Ht.
ALEE-6060FL - Flower Activity Table



Toddler Ht.
ALS-2448TR - Trapezoid Activity Table
(Shown in custom laminate Formica Gray Joseph Linen #6325)

TOP

Tabletop: 1/8" Thick Fiberboard High Pressure Laminate Surface

FRAME

Stretcher Bar: Underside For Extra Support. 60" Tables And Above

Upper Legs: 1 1/8" Outer-Diameter Powder-Coated 18-Gauge Steel with Underside Mounting Plate

Insert Legs: Chrome-Plated 1" Outer-Diameter 16-Gauge with Two Self-Locking Screws

Height Adjustable: Legs Adjust In 1" Increments

Glides: Self-leveling Nylon Glides

HIGH PRESSURE LAMINATE EDGE FINISH



Optional Items: Bookboxes, Glide Caps (Felt, Rubber and Steel), Grommets, and Power Port.

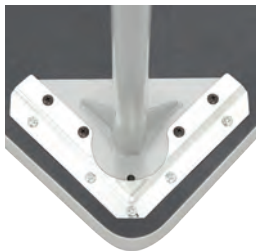

Underside Mounting Plate



Underside View



Stretcher Bar



Rectangular
Seats 2-10



Round
Seats 4-8



Trapezoid
Seats 4-5



Kidney
Seats 5-6*



Horseshoe
Seats 6-8*



Square
Seats 4-8



Clover
Seats 4



Flower
Seats 6



Squircle
Seats 4



Half Round
Seats 1

Seat qty. varies depending on dimensions.
*Plus 1 teacher seat



Fix. Standing Ht.
DHSHFBB-3660 - Butcher Block
Demonstration Table
(Shown with optional casters)

“
Engineered for durability, this welded steel table suits STEM and culinary spaces. Available in four heights with top options including Butcher Block, Epoxy, Stainless Steel, or Phenolic for versatile functionality.
”



Fix. Standard Ht.
DHFP-3060 - **Phenolic**
Demonstration Table
(Shown with standard glides)



Adj. Standing Ht.
DHSHABB-3060 - **Butcher Block**
Demonstration Table
(Shown with optional casters)



Adj. Standing Ht.
DHSHABB-4260 - **Butcher Block**
Demonstration Table
(Shown in Grey, with Standard Glides)



Double Foot Rest
Optional Casters



Phenolic Tabletop
Great For Labs

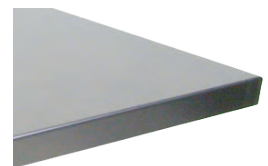

Stainless Steel Work
Surface Available Option

TOP

Phenolic: ¾". Chemical Resistant- infuses an additional barrier that resists a variety of acids, solvents and general reagents.

Epoxy: Epoxy resin is commonly used in laboratories, and has a high level of heat resistance.

Butcher Block: 1¾". Top offers a rugged yet yielding surface for precision tools. Face-glued Hardwood Strips Coated with Catalyzed Clear Lacquer, 2 top coats and 1 bottom.

FRAME

Fully Welded, Unitized Frame: 2" × 1" Rectangular 18-Gauge Steel Frame Welded to 1½" Round 16-Gauge Steel Legs

Foot Rest: Fully Welded 18-Gauge Steel

Double Footrest: Provided on tables 36" or wider

Adj. Ht. Tables

Upper Legs: 18-gauge steel Hercules style upper legs are welded to the frame by means of full contact welds.

Insert Legs: 16- Gauge Insert Legs

Height Adjustable: 23-32" H

Wheelbarrow Option: Available on Adj. Ht. Tables only. See pages 108-111 for details.

Height Options: Available In Four Height Variations

Casters/Glides: Compatible with Ht. Adj. Glides (Standard) or Heavy Duty Total Lock Casters (Optional)

Note: Casters add 2-3" to the overall height.

Optional Items: Casters & Stainless Steel Tabletops.



Durable laminate surfaces, customizable shelving, and tote bins. Locking casters or glides ensure mobility. Curved design maximizes legroom, seating 4 for collaborative, hands-on learning.



DWC36-5252 - **STEM Work Station**
(Shown in White Board laminate and X-Strong edge in Sunshine Yellow, with Z58D Drafting Stools)



DWC42-5252 - STEM Work Station with Shelves



DWC36-5252 - STEM Work Station 36" Size, with 4 Grey Tote Bins



TBC-4342 - Tote Bin Cabinet (Shown with optional Clear Bins)

TOP

Work Surface: 2702 Sq. Inches

Tabletop: 52 × 52" Collaborative Shaped Top, 1½" thick.

Color: HPL Top available in all 7 standard laminate colors.

FRAME

STEM Work Station

Cabinet Base: ¾" thick HPL. 4 individual cabinets, with doors for each side of the unit. The cabinet is 33" W × 33" D.

Color: Base cabinet is available in 6 of the standard HPL colors (not White Markerboard) and White (Wilsonart-Designer White), Graphite (Wilsonart-Slate Gray) and Light Gray (Wilsonart- Dove Gray).

Storage: Tote Bins or Shelves

Height Options: Available in Three Height Options

Casters: Heavy Duty Curved Casters (Standard)

Tote Bin Cabinet

Frame: 1½" thick HP Laminate with 3MM PVC banding constructed with dowel holes and pins

Storage: 27 Tote Bins

Casters: Heavy Duty Curved Casters (Standard)

Tote Bin

Compatible With: Demonstration Series STEM Work Station, Tote Bin Cabinet, Desks and Tables. Color options available on page 148

HIGH PRESSURE LAMINATE EDGE FINISH



T-Mold
Standard



X-Strong
Optional



PVC 3mm
Optional

Optional Items: Clear Bins, Shelves or Tote Bins.

1 of 4
Individual Cabinets



4" Total Lock Heavy Duty Casters



DWC42-5252 - STEM Work Station with Shelves & Tote Bins



Tote Bin is convenient for keeping supplies close by for immediate access.



Designed for all grades, this desk features extra legroom and adjustable height. The 500+ square inch desktop provides ample space for books and laptops, with a durable unitized steel frame.



Fix. Ht.

V2NMP-3060 - V2N Nesting Table with Modesty Panel
(Shown with Zed Cantilever Chair)



Fix. Ht.
V2F-2460 - **Illustration V2 Seminar Table**
(Shown in custom laminate Pionite Chocolate Malt #WC210)



Adj. Ht.
V2CO-2460 - **Illustration V2 Computer Table**
(Shown in custom laminate Pionite Chocolate Malt #WC210)



Fix. Ht.
V2N-3060 - **V2N Nesting Table**
(Shown in custom laminate Pionite Chocolate Malt #WC210)



Fix. Ht.
V2NMP-3060 - **V2N Nesting Table with Modesty Panel**

TOP

Tabletop: 1 1/4" Fiberboard High-Pressure Laminate Surface

Grommets: Standard Grommets for Computer Table

FRAME

Illustration V2

Welded Connection: 1" Steel Tube, 12-Gauge Steel, welded to 1 1/4" Diameter 18 Gauge Steel Stretcher Bar

Wire Management: Available on Computer Table

Fix. Ht. Illustration V2 Table

Legs: Two 1 1/2" Diameter Tubes 16-Gauge Steel

Adj. Ht. Illustration V2 Table

Upper Legs: Two 1 1/2" Diameter Tubes 16-Gauge Steel

Insert Legs: Two 1 1/2" Diameter, 16-Gauge Steel Chrome Legs with Two Self-Locking Screws

Height Adjustable: Legs Adjust In 1" Increments

V2N Nesting Table

Stretcher Bar: 2 Rectangular Steel Bars 1 1/2" x 3/4". Torsion Bar Connects The Table Top & Leg Frame Allows for a Slow And Safe Close

Lever Mechanism: Spring Loaded Auto-Lock Handle in Open/Closed Positions

Modesty Panel (V2NMP): Available on Nesting Tables

Casters/Glides: Compatible with Casters (Standard) or Ht. Adj. Glides (Optional)

Note: Casters add 2-3" to the overall height.

HIGH PRESSURE LAMINATE EDGE FINISH



T-Mold
Standard



X-Strong
Optional



PVC 3mm
Optional

Optional Items: Casters (Standard on all V2N), Grommets, Keyboard Trays, Wire Management, and Rubber Glides. Modesty Panel optional on V2N.

Matching Options

Close when not in use for more space!



Unitized Frame



One Hand Lever Mechanism



V2N Nesting Table Group
w/ Modesty Panel



Illustration V2 Desk
See page 58-59

C-Leg Series – Computer Table



Traditional tables with a modern perforated modesty panel for airflow and wire management. Available in various sizes with grommets, optional keyboard trays, and computer holders to support diverse classroom needs.



CL-2448 - Computer Table
(Shown in custom Nevamar #WM0047 Tabletop with optional Power Port)



CL-2448 - Computer Table
(Optional with Casters)



CL-2436 - Computer Table

TOP

Tabletop: 1½" Thick Fiberboard High-Pressure Laminate Surface

Grommets: Standard Grommets for Computer Table

Grommets and wire management are standard on all C-Leg tables.

Depending on the width, one, two or three computer workstations can comfortably fit on each table. See the chart on page 149 for more information.

FRAME

Frame: 17-Gauge Black Powder-Coated Rectangular Tubing 1½" × 2½"

Wire Management*: 18-Gauge Modesty Panel With Built-In Wire Management Tray

Glides: Height Adjustable Screw-In Nylon Glides

Note: Casters add 2-3" to the overall height.

HIGH PRESSURE LAMINATE EDGE FINISH



T-Mold
Standard



X-Strong
Optional



PVC 3mm
Optional

Optional Items: Casters, Connector Bridge, Keyboard Tray, Power Supply and Rubber Glides.



Built-In Wire Management
& Modesty Panel



Optional Keyboard Tray



Grommet Holes



» *Durable and affordable tables with adjustable T-legs, various sizes, and color options. Sturdy unitized frames with optional keyboard trays, computer holders, and wire-management for added functionality.* »

TLG-2460 - T-Leg Computer Table with Grommets
(Shown in custom laminate Wilsonart Beigewood #7850 with optional Keyboard Trays and Wire Management Tray.)



TL-2448 - Seminar Table
(Shown with optional Casters)



TLG-2460 - T-Leg Computer Table with Grommets
(Shown with optional Keyboard Trays and Wire Management Tray)



ADA Option Available

TOP

Tabletop: 1/8" Thick Fiberboard High-Pressure Laminate Surface

Grommets: Standard for Computer Table

Depending on the width, one, two or three computer workstations can comfortably fit on each table. See the chart on page 149 for more information.

FRAME

Upper Legs: 16-Gauge Black Powder-Coated Rectangular Tubing 1 1/2"W x 2 1/2"D

Insert Legs: 16-Gauge Chrome-Plated Rectangular Tubing with Three Self-Locking Screws. 1"W x 2"D

Wire Management: Optional on Computer Table

Height Adjustable: Legs Adjust In 1" Increments

Glides: Height Adjustable Screw-In Nylon Glides

ADA Option Available

ADA Tables are only available in Black Frame Finish.

HIGH PRESSURE LAMINATE EDGE FINISH



T-Mold
Standard



X-Strong
Optional



PVC 3mm
Optional

Optional Items: Grommets, Casters, Wire Management, and Keyboard Trays

Matching Options



T-Leg Desk
See page 60-61



T-Leg With
Three Screws



Stretcher Bar & Corner Braces



Forte Series - Group Study and Activity Table

W × D"	Standard (26-33"H)
Rectangular	
36 × 24"	FL-2436
48 × 24	FL-2448
60 × 24	FL-2460
72 × 24	FL-2472
36 × 30	FL-3036
48 × 30	FL-3048
60 × 30	FL-3060
72 × 30	FL-3072
48 × 36	FL-3648
60 × 36	FL-3660
72 × 36	FL-3672
Round	
36 × 36"	FL-36RD
42 × 42	FL-42RD
48 × 48	FL-48RD
60 × 60	FL-60RD
Trapezoid	
48 × 24"	FL-2448TR
60 × 30	FL-3060TR
Square	
36 × 36"	FL-3636SQ
48 × 48	FL-4848SQ
Clover	
48 × 48"	FL-4848CV
Flower	
60 × 60"	FL-6060FL
Kidney	
72 × 36"	FL-3672KI
72 × 48	FL-4872KI
Horseshoe	
66 × 60"	FL-6066HS
Corner	
60 × 24"	FL-2460CN
Curved	
54 × 42"	FL-4254CU
Squirrel	
36 × 36"	FL-3636SC
42 × 42"	FL-4242SC

Optional Items: Bookboxes, Casters hard or soft, grommets, hooks and power.

Wheelbarrow Option: Available for all rectangle shaped adjustable height tables. When ordering wheelbarrow option, order 1 set of casters per 2 tables.



Hercules Series – Group Study and Activity Table

W × D"	Standard (23-32"H)	Toddler (17-22"H)	Sushi (12-16"H)
Rectangular			
36 × 24"	HL-2436	HLS-2436	HLSUS-2436
48 × 24	HL-2448	HLS-2448	HLSUS-2448
60 × 24	HL-2460	HLS-2460	HLSUS-2460
72 × 24	HL-2472	HLS-2472	HLSUS-2472
48 × 30	HL-3048	HLS-3048	HLSUS-3048
60 × 30	HL-3060	HLS-3060	HLSUS-3060
72 × 30	HL-3072	HLS-3072	HLSUS-3072
60 × 36	HL-3660	HLS-3660	HLSUS-3660
72 × 36	HL-3672	HLS-3672	HLSUS-3672
Round			
36 × 36"	HL-36RD	HLS-36RD	HLSUS-36RD
42 × 42	HL-42RD	HLS-42RD	HLSUS-42RD
48 × 48	HL-48RD	HLS-48RD	HLSUS-48RD
60 × 60	HL-60RD	HLS-60RD	HLSUS-60RD
Trapezoid			
24 × 48"	HL-2448TR	HLS-2448TR	HLSUS-2448TR
30 × 60	HL-3060TR	HLS-3060TR	HLSUS-3060TR
Kidney			
72 × 36"	HL-3672KI	HLS-3672KI	HLSUS-3672KI
72 × 48	HL-4872KI	HLS-4872KI	HLSUS-4872KI
Horseshoe			
60 × 66"	HL-6066HS	HLS-6066HS	HLSUS-6066HS
Square			
36 × 36"	HL-3636SQ	HLS-3636SQ	HLSUS-3636SQ
48 × 48	HL-4848SQ	HLS-4848SQ	HLSUS-4848SQ
Clover			
48 × 48"	HL-4848CV	HLS-4848CV	HLSUS-4848CV
Flower			
60 × 60"	HL-6060FL	HLS-6060FL	HLSUS-6060FL
Inspiration			
60 × 60"	HL-6060PL	HLS-6060PL	HLSUS-6060PL
Corner			
60 × 24"	HL-2460CN	HLS-2460CN	HLSUS-2460CN
Curved			
54 × 42"	HL-4254CU	HLS-4254CU	HLSUS-4254CU
Squirrel			
36 × 36"	HL-3636SC	HLS-3636SC	HLSUS-3636SC
Half Round			
48 × 24"	HL-2448HR	HLS-2448HR	HLSUS-2448HR

Optional Items: Bookboxes, Casters, and Grommets.

Wheelbarrow Option: Available for all rectangular shaped adjustable height tables. When ordering wheelbarrow option, order 1 set of casters per 2 tables.

Edge Finish & Color Options

Forte Series

Standard: Hydraulically inserted T-Mold edge banding in Black or Gray.

Optional: Colored T-Mold edge.

Optional X-Strong Finish and PVC 3mm Finish: Are available in all standard and colored edge options.

Hercules Series

Standard: Hydraulically inserted T-Mold edge banding in Black or Gray.

Optional Educational Edge (EE): Color coordinated edge banding and legs are available for Standard and Toddler Height. Sushi height legs are only available in Black or Gray.

Optional X-Strong Finish and PVC 3mm Finish: Are available in all standard and Educational Edge colors.

See page 146 for more details.

Note the color needed at the time of ordering • All heights listed are within 3/4" variants. Casters add 2-3" to the overall height.



Harmony Series – Collaborative and Group Study Table

W x D"	Standard (23-32"H)	Toddler (17-22"H)	Sushi (12-16"H)
Rhythm			
52 x 30"	HS-3052RY	HSS-3052RY	HSSUS-3052RY
Chord			
52 x 31"	HS-3152CD	HSS-3152CD	HSSUS-3152CD
Tone			
52 x 52"	HS-5252TN	HSS-5252TN	HSSUS-5252TN
Melody			
52 x 52"	HS-5252ML	HSS-5252ML	HSSUS-5252ML



W x D"	Nesting Table Fix. (29" H)
Rhythm	
52 x 30"	V2N-3052RY
Chord	
52 x 31"	V2N-3152CD

Optional Items: Casters, and Grommets.

Table Shape

Seat qty. varies depending on dimensions.
**Plus 1 teacher seat



Dura Series – Collaborative and Group Study Table

W x D"	Standard Ht.		Standing Ht.	
	Adj. 23-32" H	Fix. 29½" H	Adj. 33-42" H	Fix. 42" H
Rectangular				
48 x 20"	WLA-2048	WLF-2048	WLSHA-2048	WLSHF-2048
60 x 20"	WLA-2060	WLF-2060	WLSHA-2060	WLSHF-2060
72 x 20"	WLA-2072	WLF-2072	WLSHA-2072	WLSHF-2072
36 x 24"	WLA-2436	WLF-2436	WLSHA-2436	WLSHF-2436
48 x 24"	WLA-2448	WLF-2448	WLSHA-2448	WLSHF-2448
60 x 24"	WLA-2460	WLF-2460	WLSHA-2460	WLSHF-2460
72 x 24"	WLA-2472	WLF-2472	WLSHA-2472	WLSHF-2472
36 x 30"	WLA-3036	WLF-3036	WLSHA-3036	WLSHF-3036
48 x 30"	WLA-3048	WLF-3048	WLSHA-3048	WLSHF-3048
60 x 30"	WLA-3060	WLF-3060	WLSHA-3060	WLSHF-3060
72 x 30"	WLA-3072	WLF-3072	WLSHA-3072	WLSHF-3072
60 x 36"	WLA-3660	WLF-3660	WLSHA-3660	WLSHF-3660
72 x 36"	WLA-3672	WLF-3672	WLSHA-3672	WLSHF-3672
60 x 42"	WLA-4260	WLF-4260	WLSHA-4260	WLSHF-4260
Adam				
60 x 60"	WLA-6060AD	WLF-6060AD	WLSHA-6060AD	WLSHF-6060AD
Chad				
60 x 42"	WLA-4260CH	WLF-4260CH	WLSHA-4260CH	WLSHF-4260CH
Round				
36 x 36"	WLA-36RD	WLF-36RD	WLSHA-36RD	WLSHF-36RD
42 x 42"	WLA-42RD	WLF-42RD	WLSHA-42RD	WLSHF-42RD
48 x 48"	WLA-48RD	WLF-48RD	WLSHA-48RD	WLSHF-48RD
60 x 60"	WLA-60RD	WLF-60RD	WLSHA-60RD	WLSHF-60RD
Trapezoid				
24 x 48"	WLA-2448TR	WLF-2448TR	WLSHA-2448TR	WLSHF-2448TR
30 x 60"	WLA-3060TR	WLF-3060TR	WLSHA-3060TR	WLSHF-3060TR
Kidney				
72 x 36"	WLA-3672KI	WLF-3672KI	WLSHA-3672KI	WLSHF-3672KI
72 x 48"	WLA-4872KI	WLF-4872KI	WLSHA-4872KI	WLSHF-4872KI
Horseshoe				
60 x 66"	WLA-6066HS	WLF-6066HS	WLSHA-6066HS	WLSHF-6066HS
Square				
48 x 48"	WLA-4848SQ	WLF-4848SQ	WLSHA-4848SQ	WLSHF-4848SQ
Clover				
48 x 48"	WLA-4848CV	WLF-4848CV	WLSHA-4848CV	WLSHF-4848CV
Flower				
60 x 60"	WLA-6060FL	WLF-6060FL	WLSHA-6060FL	WLSHF-6060FL
Squircle				
36 x 36"	WLA-3636SC	WLF-3636SC	WLSHA-3636SC	WLSHF-3636SC

Optional Items: Casters and Power Port

Wheelbarrow Option: Available for all rectangular shaped adjustable height tables. When ordering wheelbarrow option, order 1 set of casters per 2 tables.

Edge Finish & Color Options

Harmony Series

Standard: Hydraulically inserted T-Mold edge banding in Black or Gray.

Optional Educational Edge (EE): Color coordinated edge banding and legs are available for Standard and Toddler Height. Sushi height legs and Nesting tables are only available in Black or Gray.

Optional X-Strong Finish and PVC 3mm Finish: Are available in all standard and Educational Edge colors.

Dura Series

Standard: Hydraulically inserted T-Mold edge banding in Black or Gray.

Optional: Colored T-Mold edge.

Optional X-Strong Finish and PVC 3mm Finish: Are available in all standard and colored edge options.

See page 146 for more details.

Note the color needed at the time of ordering • All heights listed are within ¾" variants. Casters add 2-3" to the overall height.



Activity Series – Group-Study and Activity Table

W × D"	Standard (23-31" H)	Toddler (17-22" H)
Rectangular		
30 × 24"	AL-2430	ALS-2430
36 × 24	AL-2436	ALS-2436
48 × 24	AL-2448	ALS-2448
60 × 24	AL-2460	ALS-2460
72 × 24	AL-2472	ALS-2472
48 × 30	AL-3048	ALS-3048
60 × 30	AL-3060	ALS-3060
72 × 30	AL-3072	ALS-3072
60 × 36	AL-3660	ALS-3660
72 × 36	AL-3672	ALS-3672
Round		
36 × 36"	AL-36RD	ALS-36RD
42 × 42	AL-42RD	ALS-42RD
48 × 48	AL-48RD	ALS-48RD
60 × 60	AL-60RD	ALS-60RD
Trapezoid		
24 × 48"	AL-2448TR	ALS-2448TR
30 × 60"	AL-3060TR	ALS-3060TR
Kidney		
72 × 36"	AL-3672KI	ALS-3672KI
72 × 48"	AL-4872KI	ALS-4872KI
Horseshoe		
60 × 66"	AL-6066HS	ALS-6066HS
Square		
36 × 36"	AL-3636SQ	ALS-3636SQ
48 × 48"	AL-4848SQ	ALS-4848SQ
Clover		
48 × 48"	AL-4848CV	ALS-4848CV
Flower		
60 × 60"	AL-6060FL	ALS-6060FL
Squirrel		
36 × 36"	AL-3636SC	ALS-3636SC
Half Round		
48 × 24"	AL-2448HR	ALS-2448HR

Optional Items: Bookboxes, Glide Caps (Felt, Rubber and Steel), Grommets, and Power Port.



Demonstration Series – STEM Table

W × D"	Standard Ht.		Standing Ht.	
	Adj. 23-32" H	Fix. 29½" H	Adj. 33-42" H	Fix. 42" H
Butcher Block Top				
60 × 24"	DHABB-2460	DHFBB-2460	DHSHABB-2460	DHSHFBB-2460
60 × 30	DHABB-3060	DHFBB-3060	DHSHABB-3060	DHSHFBB-3060
60 × 36	DHABB-3660	DHFBB-3660	DHSHABB-3660	DHSHFBB-3660
60 × 42	DHABB-4260	DHFBB-4260	DHSHABB-4260	DHSHFBB-4260
Phenolic Top				
60 × 24"	DHAP-2460	DHFP-2460	DHSHAP-2460	DHSHFP-2460
60 × 30	DHAP-3060	DHFP-3060	DHSHAP-3060	DHSHFP-3060
60 × 36	DHAP-3660	DHFP-3660	DHSHAP-3660	DHSHFP-3660
60 × 42	DHAP-4260	DHFP-4260	DHSHAP-4260	DHSHFP-4260
Epoxy Top				
60 × 24"	DHAE-2460	DHFE-2460	DHSHAE-2460	DHSHFE-2460
60 × 30	DHAE-3060	DHFE-3060	DHSHAE-3060	DHSHFE-3060
60 × 36	DHAE-3660	DHFE-3660	DHSHAE-3660	DHSHFE-3660
60 × 42	DHAE-4260	DHFE-4260	DHSHAE-4260	DHSHFE-4260

Optional Items: Casters & Stainless Steel Tabletops.

Wheelbarrow Option: Available for all rectangular shaped adjustable height tables. When ordering wheelbarrow option, order 1 set of casters per 2 tables.

Demonstration Series – STEM Workstation



Table Ht.	W × D"	Bins/Side	Shelves	Model
With Tote Bins*				
30"	52 × 52"	3	—	DWC30-5252
36	52 × 52	4	—	DWC36-5252
42	52 × 52	6	—	DWC42-5252
Mix of Tote Bins*/Shelves				
30"	52 × 52"	3	1	DWCS30-5252
36	52 × 52	4	2	DWCS36-5252
42	52 × 52	6	2	DWCS42-5252
With Shelves				
30"	52 × 52"	—	1	DW30-5252
36	52 × 52	—	2	DW36-5252
42	52 × 52	—	2	DW42-5252

Demonstration Series – Tote Bin Cabinet



Ht.	W × D"	Bins	Shelves	Model
42"	43 × 13"	27	—	TBC-4342

Optional Items: Clear Bins, Shelves or Tote Bins.

*Color options for Tote Bins are available on page 148

Edge Finish & Color Options

Activity Series

Standard: Hydraulically inserted T-Mold edge banding in Black or Gray.

Optional Educational Edge (EE): Color coordinated edge banding and legs are available for Standard and Toddler Height.

Optional X-Strong Finish and PVC 3mm Finish: Are available in all standard and Educational Edge colors.

Demonstration Series – STEM Workstation

Standard: Hydraulically inserted T-Mold edge banding in Black or Gray. Colored edge is optional.

See page 146 for more details.

Note the color needed at the time of ordering • All heights listed are within ¾" variants. Casters add 2-3" to the overall height.

Illustration V2 Series – Seminar Table

W x D"	Adj. 27½-31½" H	Fix. 29" H
Seminar Table		
48 x 20"	V2A-2048	V2F-2048
60 x 20	V2A-2060	V2F-2060
72 x 20	V2A-2072	V2F-2072
36 x 24	V2A-2436	V2F-2436
48 x 24	V2A-2448	V2F-2448
60 x 24	V2A-2460	V2F-2460
72 x 24	V2A-2472	V2F-2472
36 x 30	V2A-3036	V2F-3036
48 x 30	V2A-3048	V2F-3048
60 x 30	V2A-3060	V2F-3060
72 x 30	V2A-3072	V2F-3072



W x D"	Adj. 27½-31½" H	Fix. 29" H
Nesting Table Fixed		
48 x 24"	—	V2N-2448
60 x 24	—	V2N-2460
72 x 24	—	V2N-2472
48 x 30	—	V2N-3048
60 x 30	—	V2N-3060
72 x 30	—	V2N-3072



W x D"	Adj. 27½-31½" H	Fix. 29" H
Nesting Table Fixed w/ Modesty Panel		
48 x 24"	—	V2NMP-2448
60 x 24	—	V2NMP-2460
72 x 24	—	V2NMP-2472
48 x 30	—	V2NMP-3048
60 x 30	—	V2NMP-3060
72 x 30	—	V2NMP-3072



Illustration V2 Series – Computer Table

W x D"	Adj. 27½-31½" H	Fix. 29" H
Computer Table		
36 x 24"	V2ACO-2436	V2FCO-2436
48 x 24	V2ACO-2448	V2FCO-2448
60 x 24	V2ACO-2460	V2FCO-2460
72 x 24	V2ACO-2472	V2FCO-2472
36 x 30	V2ACO-3036	V2FCO-3036
48 x 30	V2ACO-3048	V2FCO-3048
60 x 30	V2ACO-3060	V2FCO-3060
72 x 30	V2ACO-3072	V2FCO-3072



Optional Items: Casters (Standard on all V2N), Grommets, Keyboard Trays, Wire Management, and Rubber Glides. Modesty Panel optional on V2N.

C-Leg Series – Computer Table

W x D"	Fix. 29½" H
Computer Tables	
30 x 24"	CL-2430
36 x 24	CL-2436
48 x 24	CL-2448
60 x 24	CL-2460
72 x 24	CL-2472
48 x 30	CL-3036
48 x 30	CL-3048
60 x 30	CL-3060
72 x 30	CL-3072



Optional Items: Casters, Connector Bridge, Keyboard Tray, Power Supply and Rubber Glides.

Grommets and wire management are standard on all C-Leg tables. Depending on the width, one, two or three computer workstations can comfortably fit on each table. See the chart on page 149 for more information.

T-Leg Series – Seminar Table

W x D"	Adj. 22½-32½" H	Adj. ADA 30-35" H
Seminar Tables		
36 x 24"	TL-2436	—
48 x 24	TL-2448	TLADA-2448
60 x 24	TL-2460	TLADA-2460
72 x 24	TL-2472	TLADA-2472
36 x 30	TL-3036	—
48 x 30	TL-3048	TLADA-3048
60 x 30	TL-3060	TLADA-3060
72 x 30	TL-3072	TLADA-3072
60 x 36	TL-3660	TLADA-3660
72 x 36	TL-3672	TLADA-3672



T-Leg Series – Computer Table

W x D"	Adj. 22½-32½" H	Adj. ADA 30-35" H
Computer Table		
36 x 24"	TLG-2436	—
48 x 24	TLG-2448	TLGADA-2448
60 x 24	TLG-2460	TLGADA-2460
72 x 24	TLG-2472	TLGADA-2472
36 x 30	TLG-3036	—
48 x 30	TLG-3048	TLGADA-3048
60 x 30	TLG-3060	TLGADA-3060
72 x 30	TLG-3072	TLGADA-3072
60 x 36	TLG-3660	TLGADA-3660
72 x 36	TLG-3672	TLGADA-3672



Optional Items: Grommets, Casters, Wire Management, and Keyboard Trays

ADA Tables are only available in Black Frame Finish. Depending on the width, one, two or three computer workstations can comfortably fit on each table. See the chart on page 149 for more information.

Edge Finish & Color Options

Illustration V2 Series

Standard: Hydraulically inserted T-Mold edge banding in Black or Gray.

Optional: Colored T-Mold edge.

Optional X-Strong Finish and PVC 3mm Finish: Are available in all standard and colored edge options.

C-Leg Series & T-Leg Series

Standard: Hydraulically inserted T-Mold edge banding in Black or Gray.

Optional: Colored T-Mold edge.

Optional X-Strong Finish and PVC 3mm Finish: Are available in all standard and colored edge options.

See page 146 for more details.

Note the color needed at the time of ordering • All heights listed are within ¾" variants. Casters add 2-3" to the overall height.

Kinect Series – Teacher Desk



Kinect offers easy mobility, allowing desk and podium to move together or separately. The podium features a magnetic design, key-locked cabinet, and secure casters, with a wide range of color options.



TSKT-2460 - Kinect Mobile Teacher Workstation



TSKT-2460 - Kinect Mobile Teacher Workstation



TSKT-2440 - Kinect Mobile Teacher Desk
(Shown in custom laminate White Drops)



Strong Magnetic Connection



Molded Comfort Handles with concealed magnet



Tilted Podium

TOP

Work Surface: 960 Sq. Inches

Tabletop: 1 1/8" fiberboard with high pressure laminate surface. Desk height is 29 1/2".

Pencil Drawer: 21" x 16" featuring compartments for pens and paper clips. This drawer features a ball-bearing suspension.

FRAME

Modesty Panel: 4 3/4" Modesty panel; 18-gauge perforated panel adds design and comfort.

Legs: Tapered 14-gauge steel legs end with casters and a connecting bar for frame strength.

Caster: 3" swivel locking casters.

PODIUM

Frame: Powder coated steel box. The pedestal is 19 1/2" W x 24" D x 43 1/2" H and is outfitted with four 3" swivel locking casters.

Angled Podium Surface: Attached to a steel heavy-duty post with 2 bolts. Angle of the podium top is 12 degrees.

Locking Drawers: Steel locking door houses two shelves; 1 is height adjustable. Locking file drawer is full extension with ball-bearing suspension. It measures 12 1/2" W x 19" D (13" of easy access space) and 9" H.

HIGH PRESSURE LAMINATE EDGE FINISH



T-Mold Standard



The Nate Teacher Station combines sleek design with innovation, featuring locking storage, mobile podium, and adjustable return. Built-in casters, modesty panel, and durable construction offer adaptability and comfort.



TSPM-2468 - Nate Teacher Station with Mobile Podium
(Shown in Driftwood Laminate)



TSPM-1824 - Podium



TSP-2468 - Right Handed Teacher Station
w/ Stationary Podium

TOP

Work Surface: 2230 Sq. Inches

Tabletop: 1/8" Fiberboard with High Pressure Laminate Surface

FRAME

Modesty Panel: Powder Coated 18 Gauge Steel

Retractable Return

3 Legs: 2 3/8" Diameter, Powder Coated, 16 Gauge Steel Legs, screwed into Heavy Duty Table Inserts.

Caster/Glide: Inverted Caster for the Inner Pivot Leg & Rubber Lined Glide for the Stationary Leg. Heavy Duty Locking Caster on Pivot Leg

Left or Right Return (LH/RH) Option: Must note if retractable return is wanted on right or left side of the teacher station at the time of ordering. Add LH/RH to the model number.

Podium

Frame: Powder Coated Steel Box

Power Port: Power is on the right or the left or the center of the Mobile Podium only, not the desk, due to the pullout.

Adjustable Podium Top: Ranging from 29-42" High

Angled Podium Surface: Adjusting to 45 Degrees

Locking Drawers: 2 Drawers & 1 Ball Bearing File Drawer

HIGH PRESSURE LAMINATE EDGE FINISH



PVC 3mm
Standard

Optional Items: Power Supply for Podium (2 AC power or 1 AC with 2 USB outlets).



Tilted Podium



Optional Power Supply for Podium
Available in both Grey and Black



Inset Caster



Heavy Duty Locking Caster



Scan to Watch Demo



Nate Series – Teacher Desk



Sleek and functional Nate Teacher Desk offers roomy, locking storage, sturdy construction, and a modesty panel. Built with heavy-duty steel and inverted casters for easy mobility and long-lasting durability.



TS-3060 - Double Pedestal Desk



TS-3048 - **Single Pedestal Desk**
(Shown in custom laminate Formica
Smokey Brown Pear #5488)



TS-3672P - **Left Handed Peninsula Desk**
(Shown in custom laminate Formica
Smokey Brown Pear #5488)



TS-3060 - **Double Pedestal Desk**

TOP

Single Pedestal Work Surface: 1420 Sq. Inches

Peninsula Tabletop: 36" Diameter; Rectangular End
30" Deep

Double Pedestal Work Surface: 1788 Sq. Inches

Tabletop: 1 1/8" Fiberboard with High Pressure
Laminate Surface

Power Port: Can be placed on the right, left or center
of the desk.

FRAME

Modesty Panel: Powder Coated 18 Gauge Steel

2 Legs: 2 3/8" Diameter; Powder Coated, 16 Gauge Steel
(Single Pedestal & Peninsula Only)

Pedestal

Single Pedestal: Power Coated Steel Pedestal

Drawers: 2 Locking Drawers & 1 Ball-Bearing File
Drawer

Double Pedestal: 2 Powder Coated Steel Pedestals

Drawers: 4 Locking Drawers & 2 Ball-Bearing File
Drawer

Caster: 2 Inverted Casters

HIGH PRESSURE LAMINATE EDGE FINISH



PVC 3mm
Standard

Optional Items: 2" locking casters (available on
Double Pedestal desk), Keyboard Tray, Pencil Tray, Power
Supply.

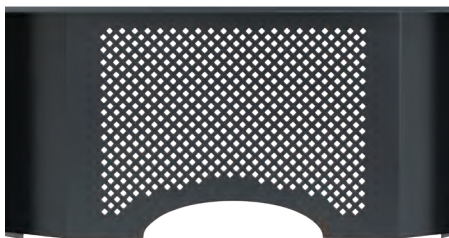

Sleek Modesty Panel



Built In Lock



Drawer Suspension Pull-Out

Petal Series – Lazer Teacher Desk



Hexagonal teacher's desk with arched front, modesty panel, and pencil drawer. Durable laminate top, edge banding, and gliding casters ensure easy reconfiguration for collaborative, multi-student clusters.



TS-2868 - Lazer Teacher Desk
(Shown in custom laminate Formica Indigo)



TS-2868 - Lazer Teacher Desk

TOP

Work Surface: 1305 Sq. Inches

Tabletop: 1/8" Particleboard Core with a 1/32" High Pressure Laminated Surface, and .020" Poly Backer Sheet Covered Underside

Pencil Drawer: 21" W × 16" D

FRAME

Modesty Panel: 18-Gauge Perforated Panel Extends 15"

Upper Legs: 2" Diameter, 18-Gauge Steel Powder Coated Finish

Insert Legs: 1.875", 16 Gauge Steel, Chrome Plated Finish with Two Self-Locking Screws

Height Adjustable: Legs Adjust In 1" Increments

Caster: Braking Casters Are Standard

HIGH PRESSURE LAMINATE EDGE FINISH



PVC 3mm
Standard

Matching Options



Jr. Petal Desk
See page 54-55



Heavy Duty
Locking Caster

Modesty Panel

TS-2868 - Lazer Teacher Desk
(Shown with 1950 Junior Petal Desk with optional casters)

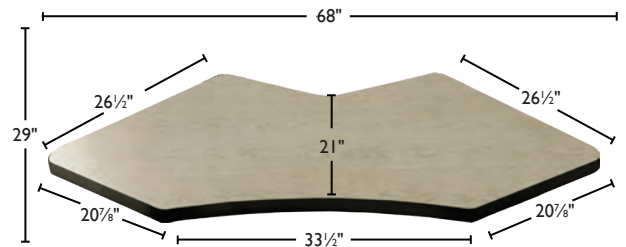

Scan to Watch Demo



Vantage Series – Teacher Desk



Standing Fix. Ht.
TVSHF-2430 - Vantage Teacher Desk
(Shown with optional Casters and Cup Holder)



Mobile teacher's desk with adjustable or fixed height, footrest, and power source option. Includes modesty panel, pencil drawer, and casters or glides. Comfortable, versatile, and perfect for classroom flow.





Fix. Standard Ht.
 TVF-2430 - **Vantage Teacher Desk**
 (Shown with optional Casters & Pencil Drawer;
 in custom laminate Wilsonart Aqua Fizz #4934)



Adj. Standing Ht.
 TVSHA-3048 - **Vantage Teacher Desk**
 (Shown with optional Power Supply & Casters)

TOP

2430 Work Surface: 700 Sq. Inches

3048 Work Surface: 1420 Sq. Inches

Tabletop: 1 1/8" Particleboard Core with a 1/32" High Pressure Laminated Surface, and .020" Poly Backer Sheet Underside

FRAME

Unitized Steel Frame: 2" x 1" 18-Gauge Rectangular Tubes

Modesty Panel: 18-Gauge Perforated Steel

Fix. Ht

Foot Rest: 18-Gauge Steel

Adj. Standing Ht

Upper Legs: 1 7/8" Diameter 16-Gauge Steel

Insert Legs: Chrome-Plated 2" Round 16-Gauge Steel with Two Self-Locking Screws

Height Adjustable: Legs Adjust In 1" Increments

Casters/Glides: Compatible with Ht. Adj. Glides (Standard) or Casters (Optional)

HIGH PRESSURE LAMINATE EDGE FINISH



T-Mold
 Standard

Optional Items: Casters, Pencil Drawer, Power Port.



Optional
 Pencil Tray

Foot Rest



Optional Power Port



Modesty Panel



Kinect Series – Teacher Desk

Ht."	W × D"	Right Return
Teacher Desk		
29½"	40 × 24"	TSKT-2440
Podium		
43½"	19½ × 24"	TSKT-1924
WorkStation w/ Mobile Podium		
43½"	59½ × 24"	TSKT-2460



Nate Series – Teacher Station

Desk Ht."	W × D"	Right Return	Left Return
Teacher Station w/ Stationary Podium			
29"	68 × 24"	TSP-2468RH	TSP-2468LH
Teacher Station w/ Mobile Podium			
29"	68 × 24"	TSPM-2468-RH	TSPM-2468-LH



Nate Series – Podium

Desk Ht."	W × D"	Model
29"	18½ × 24"	TSPM-1824

Optional Items: Power Supply for Podium (2 AC power or 1 AC with 2 USB outlets).



Nate Series – Teacher Desk

Desk Ht."	W × D"	Model
Single Pedestal		
29"	48 × 30"	TS-3048



Desk Ht."	W × D"	Right Handed, Left Peninsula	Left Handed, Right Peninsula
Peninsula			
29"	72 × 36"	TS-3672P	TS-3672-LH



Desk Ht."	W × D"	Model
Double Pedestal		
29"	60 × 30"	TS-3060

Optional Items: 2" locking casters (available on Double Pedestal desk), Keyboard Tray, Pencil Tray, Power Supply.



Optional Power Port available for all Teachers Desks

Edge Finish & Color Options

Kinect Series

Hydraulically inserted T-Mold edge banding in Black or Gray. Available in colored edge.

Nate Series Teacher Station/Teacher Desk

PVC 3mm edge banding in Black. Driftwood HPL standard edge is Gray. Either Black or Gray can be requested.

See page 146 for more details.

Note the color needed at the time of ordering • All heights listed are within ¾" variants. Casters add 2-3" to the overall height.



Petal Series – Lazer Teacher Desk

Desk Ht."	W × D"	Model
Lazer Teacher Desk		
23-32"	68 × 29"	TS-2868

Vantage Series – Teacher Desk



W × D"	Standard Ht.	Standing Ht.	
30 × 24"	Fix. 29" H	Fix. 42" H	Adj. 33-42" H
48 × 30	TVF-3048	TVSHF-2430	TVSHA-2430
		TVSHF-3048	TVSHA-3048

Optional Items: Casters, Pencil Drawer, Power Port.

Surge Series – School Desk



W × D"	Standard Ht.	
	Adj. 26½-38½" H	Adj. 29-42" H
High Pressure Laminate		
26½ × 24"	1626	1629
Hard-Plastic		
26¾ × 19½"	1626HP	1629HP
WoodStone		
26¾ × 19½"	1626WS	1629WS

For More Information
See pages 56 - 57 Surge Series

Optional Items: Backpack Hook, Cup Holder, Mesh Bookbox, Rubber Glides, and Tote Bin.



Edge Finish & Color Options

Petal Series Lazer Desk

PVC 3mm edge banding in Black. Driftwood HPL standard edge is Gray. Either Black or Gray can be requested.

Vantage Series

Hydraulically inserted T-Mold edge banding in Black or Gray. Available in colored edge.

See page 146 for more details.

Note the color needed at the time of ordering • All heights listed are within ¾" variants. Casters add 2-3" to the overall height.



Perfect Media Center desk with plenty of surface area for the librarian, and functional transaction counter. Built with high quality laminate top and sides, fully unitized steel frame, and heavy-duty locking casters for mobility.

CS-7528 - Circulation Desk



CS-7528 - Circulation Desk

CIRCULATION DESK

Total Work Surface: 2420 Square Inches

Tabletop: 1/8" fiberboard with high pressure laminate surface. Desk height is 29 1/2"

Pencil Drawer: 21"W x 16"D (standard)

Transaction Counter: 3/4" fiberboard with laminate surface, with steel support bars. 44" wide x 9" deep, and 6" tall

Desk Frame: 16-Gauge fully unitized steel frame in gray powder coat

Casters: 3" Heavy Duty Locking Casters

HIGH PRESSURE LAMINATE EDGE FINISH



T-Mold
Standard



CS-BR3224 - Book Return Unit



CS-BR3224 - Book Return Unit with Standard Cushion for Padding

BOOK RETURN UNIT

Frame: 3/4" fiberboard with 1" laminate surface top and sides. Two doors and handles for easy access and book slot on top. 32" wide x 24" deep, and 29" tall.

Casters: 3" Heavy Duty Locking Casters

Standard Cushion: 1" thick

HIGH PRESSURE LAMINATE EDGE FINISH



PVC 3mm
Standard



Sturdy Transaction Counter

Optional Items: Power Port Available for Circulation Desk Tabletop



Heavy Duty Locking Casters

STAX Curved Bookcase – Single & Double-Sided



Simple and sturdy design with industrial-grade steel frames, adjustable shelves, and heavy-duty construction. Modular units combine for versatile configurations, with casters for easy mobility.



BCURM-6048 - **Stax Curved Single Bookcases**
(Shown with HLS-4254CU - Hercules Curved Table & SQ-18 - Squirel® Stools)



BCURDM-6036 - Stax Curved Double Bookcases



BCURM-6036 - Stax Curved Bookcases

BOOKCASES

Back Surface: ¾" Thick Fiberboard High-Pressure Laminate

Edge-Banding: All standard laminate Bookcases have matching PVC 3mm Edge Banding, except Gray Nebula, which comes standard with Black Edge Banding. Driftwood has Gray Edge Band but can be requested with Black.

Shelf Surface: 1 ½" Thick Fiberboard, High-Pressure Laminate

Adjustable Shelves: Shelves have counter sunk holes for pin support. Dowel holes & pins are held together by L-Brackets screwed in place

White Board Laminate color is not standard on Bookcases.

See page 134 for shelf quantities.

Casters: Heavy Duty Curved Casters

HIGH PRESSURE LAMINATE EDGE FINISH



PVC 3mm
Standard

Matching Options



**Hercules
Curved Table**
See page 90-91



Arc 6 Mod®
See page 40-41



Adjustable Shelves Securely
Held by Push Pins



Heavy Duty Locking Casters



Serpentile

STAX Bookcase – Single and Double-Sided Bookcase



Durable, mobile units with adjustable shelves and strong steel frames. Versatile configurations for seating, reading areas, or room dividers. Customizable colors to fit any space.



Stax Bookcases

(Shown in custom laminate Formica White Malachite #9949 Various sizes, available in both single and double-sided)



BCD-3648 - Double-Sided Bookcase



BC-3636 - Single-Sided Bookcase

BOOKCASES

Back Surface: ¾" Thick Fiberboard High-Pressure Laminate

Edge-Banding: All standard laminate Bookcases have matching PVC 3mm Edge Banding, except Gray Nebula, which comes standard with Black Edge Banding. Driftwood has Gray Edge Band but can be requested with Black.

Shelf Surface: 1/8" Thick Fiberboard, High-Pressure Laminate

Adjustable Shelves: Shelves have counter sunk holes for pin support. Dowel holes & pins are held together by L-Brackets screwed in place. (All bookcases 60" and above have a fixed shelf. Amount of shelves change depending on the overall size of the bookcase.)

White Board laminate color is not standard on Bookcases.

See page 134 for shelf quantities.

Glides: Adjustable Nylon Glides

Mobile Bookcases

Frame: 1" X 1" Fully Welded Square Tubing

Casters: 3" Heavy Duty Casters (*Double Mobile Bookcases Only*)

HIGH PRESSURE LAMINATE EDGE FINISH



PVC 3mm
Standard



Adjustable Shelves



Self-Leveling Glides



Heavy-Duty Steel Frame

Boost Series – Café Tables & Stools



QCF-3636SQCL - 30" Ht. Squircle Quad Café Tables



Create a collaborative café atmosphere with customizable tables and curved chairs, offering device charging, comfort, and durability for students to relax, connect, and work effectively.





Toddler 18" Ht.
Regular Base



Standard 30" Ht.
Regular or Quad Base



Jr Standing 36" Ht.
Regular Base



Standing 42" Ht.
Regular or Quad Base



**Z430G - 30" Zed
Café Stool**



**Z424G - 24" Zed
Café Stool**



CFSH-3672OV & 7430 - **Oval Table and Inspiration Boost Stool**

SEATING

Shell: One-Piece, Color-Impregnated Polypropylene Molded Plastic with Built-in Carry Handle

Back: Integral Lumbar Supports & Smooth Back

Steel Legs: Fully Unitized 14-Gauge, 1" Diameter

Steel Foot Rest: Angled 14-Gauge, 3/4" Diameter
Steel Legs and Foot Rest available in Chrome-Plated

Zed Café Stool Only: Gray (G) Powder Coating or Black (B) Powder Coating Legs and Foot Rest available.

Glides: Self Leveling Nylon Glides

TABLE

Tabletop: 1 1/8" Particleboard Core 1/2" High Pressure Laminated

Backer Sheet: Underside .020" Poly

Upper Frame: Four 16-Gauge Plate Attached to Tabletop by 16 Screws. 1 6/8" upper steel support.

Frame Finish: Available in Black or Tungsten

Legs: 16 Gauge, 1 3/4" Diameter

Post: 3" Dia.

Base

Regular Base: 12-Gauge, 22" Dia.

Quad Base: 30" Dia. Only available in Tungsten Gray.

Glides: Adjustable 2" Rubber Glide

HIGH PRESSURE LAMINATE EDGE FINISH



T-Mold
Standard



X-Strong
Optional



PVC 3mm
Optional

Optional Items: Power Port, Glide Caps (Felt, Rubber and Steel)



PVC 3mm Edge
(Shown in Aqua)



Optional Power Port



Regular Base



Quad Base



Adjustable Glide

Round Table
Regular or Quad Base



30"



36"



42"

Square Table
Regular or Quad Base



30 x 30"

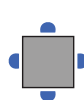

36 x 36"

Squircle Table
Quad Base



36 x 36"

Oval Table
Regular or Quad Base



36 x 60"



36 x 72"

Oval not available in Toddler Ht.

Study Carrel Series – Study Carrel



SCWLA-3660 - Double Study Carrel
Shown with Dura Leg Frame



Create focused workspaces with adjustable, sturdy units featuring sound-absorbing partitions for privacy, ideal for individual achievement, testing, or distraction-free study.





SCV2A-2436 - **Single Study Carrel**
Shown with Adj. Ht. Illustration V2 Frame



SCV2F-2460 - **Double Study Carrel**
Shown in Wild Cherry with
Fix. Ht. Illustration V2 Frame



SCTL-3660 - **Quad Study Carrel**
Shown in custom laminate Formica Ashen
Ribbonwood 8839 & marker board laminate
for work surface



Stable T-Leg



Easy Assembly with Dowels



Top Shelf Available

TOP

Surface: 1/8" Thick Fiberboard High-Pressure Laminate
Top Shelf: 10"D Top Shelf not available on Quad Study Carrels

Partitions: 3/4" Thick High Pressure Laminated On MDF
White Board Laminate color is not standard on Study Carrels.

T-LEG FRAME

Stretcher Bar: 16-Gauge Black Powder-Coated Rectangular Tube 1 1/8"W x 2 1/8"D

Upper Legs: 16-Gauge Black Powder-Coated 1 1/8"W x 2 1/8"D

Insert Legs: 16-Gauge Chrome-Plated Rectangular Tubing 1"W x 2"D

Glides: Screw-In Style, Nylon Base Glides

T-Leg Frame not available with a Light Gray frame finish.

DURA FRAME

Fully Welded, Unitized Frame: 2" x 1" Rectangular 16-Gauge Steel Frame welded to 1 1/8" Round 16-Gauge Steel Legs

Upper Legs: Available in Black or Tungsten Color

Insert Legs: Chrome-Plated 2" Round 16-Gauge Steel

Height Adjustable: Legs Adjust In 1" Increments

Height Options: Available In Four Height Variations

Casters/Glides: Compatible with Ht. Adj. Glides (Standard) or Casters (Optional)

Note: Casters add 2-3" to the overall height.

ILLUSTRATION V2 FRAME

Welded Connection: 1" Steel Tube, 12-Gauge Steel, welded to 1/4" Diameter 18 Gauge Steel Stretcher Bar

Wire Management: Available on Computer Table

Fix. Ht. Illustration V2 Table

Legs: Two 1 1/2" Diameter Tubes 16-Gauge Steel

Adj. Ht. Illustration V2 Table

Upper Legs: Two 1 1/2" Diameter Tubes 16-Gauge Steel

Insert Legs: Two 1 1/8" Diameter; 16-Gauge Steel Chrome Legs with Two Self-Locking Screws

Height Adjustable: Legs Adjust In 1" Increments

HIGH PRESSURE LAMINATE EDGE FINISH



PVC 3mm
Standard

Optional Items: Grommets



Circa Series - Circulation Desk

Ht"	W x D"	Model
Circulation Desk		
29½"	75 x 28"	CS-7528
Book Return Unit		
29½"	32 x 24"	CS-BR3224

Optional Items: Power Port Available for Circulation Desk Tabletop

STAX Bookcase – Single and Double-Sided Bookcase

Ht."	W x D"	Shelves Per Side	Model
Single Bookcases			
36"	36 x 12"	1 Adj., 1 Fix. Bottom	BC-3636
48"	36 x 12"	2 Adj., 1 Fix. Bottom	BC-3648
60"	36 x 12"	2 Adj., 1 Fix. Center; 1 Fix. Bottom	BC-3660
72"	36 x 12"	3 Adj., 1 Fix. Center; 1 Fix. Bottom	BC-3672
84"	36 x 12"	4 Adj., 1 Fix. Center; 1 Fix. Bottom	BC-3684
Double Bookcases			
36"	36 x 24"	1 Adj., 1 Fix. Bottom	BCD-3636
48"	36 x 24"	2 Adj., 1 Fix. Bottom	BCD-3648
60"	36 x 24"	2 Adj., 1 Fix. Center; 1 Fix. Bottom	BCD-3660
72"	36 x 24"	3 Adj., 1 Fix. Center; 1 Fix. Bottom	BCD-3672
84"	36 x 24"	4 Adj., 1 Fix. Center; 1 Fix. Bottom	BCD-3684
Double Mobile Bookcases			
36"	36 x 24"	1 Adj., 1 Fix. Bottom	BCDM-3636
48"	36 x 24"	2 Adj., 1 Fix. Bottom	BCDM-3648

White Board laminate color is not standard on Bookcases.

STAX Curved Bookcase – Single and Double-Sided Bookcase

Ht."	W x D"	Shelves Per Side	Model
Single Bookcases			
36"	60 x 12"	4 Adj., 2 Fix. Bottom	BCURM-6036
42"	60 x 12"	4 Adj., 2 Fix. Bottom	BCURM-6042
48"	60 x 12"	4 Adj., 2 Fix. Bottom	BCURM-6048
Double Bookcases			
36"	60 x 24"	4 Adj., 2 Fix. Bottom	BCURDM-6036
42"	60 x 24"	4 Adj., 2 Fix. Bottom	BCURDM-6042
48"	60 x 24"	4 Adj., 2 Fix. Bottom	BCURDM-6048

White Board Laminate color is not standard on Bookcases.

Study Carrel Series – Study Carrel

W x D"	T-Leg Frame	Dura Frame		Illustration V2 Frame	
	22½-32½"H	Adj. 23-32" H	Fix. 29½" H	Adj. 27½-31½" H	Fix. 29" H
Single Study Carrel					
36 x 24"	SCTL-2436	SCWLA-2436	SCWLF-2436	SCV2A-2436	SCV2F-2436
Double Study Carrel					
60 x 24"	SCTL-2460	SCWLA-2460	SCWLF-2460	SCV2A-2460	SCV2F-2460
Quad Study Carrel					
60 x 36"	SCTL-3660	SCWLA-3660	SCWLF-3660	SCV2A-3660	SCV2F-3660

Optional Items: Grommets

T-Leg Frame not available with a Light Gray frame finish.

White Board Laminate color is not standard on Study Carrels.

Top Shelf: 10"D Top Shelf not available on Quad Study Carrels

Edge Finish & Color Options

STAX Bookcase and STAX Curved Bookcase

All standard laminate Bookcases have matching PVC 3mm Edge Banding, except Gray Nebula, which comes standard with Black Edge Banding. Either Black or Gray can be requested.

Study Carrel

PVC 3mm edge banding; standard Black.

See page 146 for more details.

Note the color needed at the time of ordering • All heights listed are within ¼" variants.

Boost Series – Café Tables

Table Ht."	W × D"	Model
Round Café Tables		
18"	30"	CFT-30RD
18	36	CFT-36RD
18	42	CFT-42RD
30	30	CF-30RD
30	36	CF-36RD
30	42	CF-42RD
36	30	CFJ-30RD
36	36	CFJ-36RD
36	42	CFJ-42RD
42	30	CFSH-30RD
42	36	CFSH-36RD
42	42	CFSH-42RD
Square Café Tables		
18"	30 × 30"	CFT-3030SQ
18	36 × 36	CFT-3636SQ
30	30 × 30	CF-3030SQ
30	36 × 36	CF-3636SQ
36	30 × 30	CFJ-3030SQ
36	36 × 36	CFJ-3636SQ
42	30 × 30	CFSH-3030SQ
42	36 × 36	CFSH-3636SQ
Oval Double Base Café Tables		
30"	36 × 60"	CF-3660OV
30	36 × 72	CF-3672OV
36	36 × 60	CFJ-3660OV
36	36 × 72	CFJ-3672OV
42	36 × 60	CFSH-3660OV
42	36 × 72	CFSH-3672OV

Optional Items: Power Port

Boost Series – Quad Café Tables

Table Ht."	W × D"	Model
Round Quad Café Tables*		
30"	30"	QCF-30RD
30	36	QCF-36RD
30	42	QCF-42RD
36	30	QCFJ-30RD
36	36	QCFJ-36RD
36	42	QCFJ-42RD
42	30	QCFSH-30RD
42	36	QCFSH-36RD
42	42	QCFSH-42RD
Square Quad Café Tables*		
30"	30 × 30"	QCF-3030SQ
30	36 × 36	QCF-3636SQ
30	42 × 42	QCF-4242SQ
36	30 × 30	QCFJ-3030SQ
36	36 × 36	QCFJ-3636SQ
36	42 × 42	QCFJ-4242SQ
42	30 × 30	QCFSH-3030SQ
42	36 × 36	QCFSH-3636SQ
42	42 × 42	QCFSH-4242SQ
Squircle Quad Café Tables*		
30"	36 × 36"	QCF-3636SC
36	42 × 42	QCFJ-4242SC
42	36 × 36	QCFSH-3636SC
Oval Quad Café Tables*		
30"	36 × 60"	QCF-3660OV
30	36 × 72	QCF-3672OV
36	36 × 60	QCFJ-3660OV
36	36 × 72	QCFJ-3672OV
42	36 × 60	QCFSH-3660OV
42	36 × 72	QCFSH-3672OV

Optional Items: Power Port

*Quad legs are only available in gray.

Boost Series – Café Stools

Seat Ht."	W × D"	Frame Color		
		Chrome	Gray Powder Coating	Black Powder Coating
Inspiration Café Stools				
24"	19½ × 22½"	7424	—	—
30	19½ × 22½"	7430	—	—
Zed Café Stools				
24"	19½ × 22½"	Z424	Z424G	Z424B
30	19½ × 22½"	Z430	Z430G	Z430B

Optional Items: Glide Caps (Felt, Rubber and Steel).

Edge Finish & Color Options**Boost Series - Cafe Tables**

Standard: Hydraulically inserted T-Mold edge banding in Black or Gray.

Optional: Colored T-Mold edge.

Optional X-Strong Finish and PVC 3mm Finish: Are available in all standard and colored edge options.

See page 146 for more details.

Note the color needed at the time of ordering • All heights listed are within ¾" variants.

Mobile Easel & Knapsack Rack

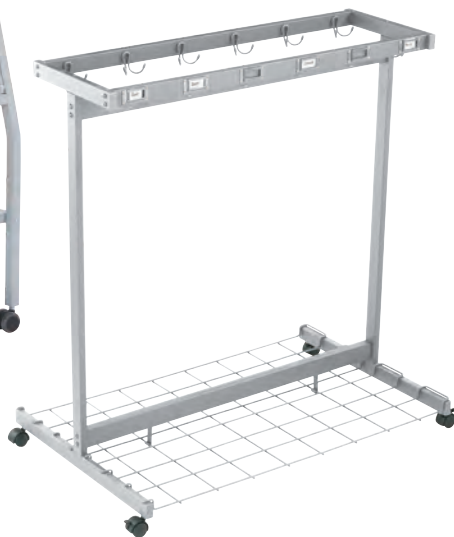

Mobile and sturdy, this rack features 12 rubber-top hooks, boot storage, and casters for easy movement, while the durable easel offers a wipe-off surface and secure portability.



7700 - Mobile Easel & 4670 - Mobile Knapsack Rack
(Accessories shown not included)



7700 - **Mobile Easel**
(Accessories shown not included)



4670 - **Mobile Knapsack Rack**
(Accessories shown not included)

MOBILE EASEL

Dry-Erase Board: Porcelain Magnetic Marker Board Encased In Metal Frame 30" x 30"

Unitized Frame: 1" Square Steel Tubing, Powder-Coated

Tray Supports: Steel Frame 23¼"W x 28"D

Tray: 4 - Rectangular Plastic Holding Removable Trays 9" x 12" x 3"

Casters: 4 - Standard 2" Heavy-Duty Locking Casters

MOBILE KNAPSACK RACK

Size: 38"W x 41½"H x 24"D

Hooks: 6 rubber tip double hooks per side, 12 per unit. A name plate by each hook.

Bottom Rack: comes standard with bottom rack for boots. 16 gauge steel frame and 18 gauge steel crossbar.

Finish: Gray textured powder coated finish.

Casters/Glides: Standard with 4 Glides or Casters (2 that lock).



Mobile Easel
Storage Compartments, Unitized Frame
& Locking Casters

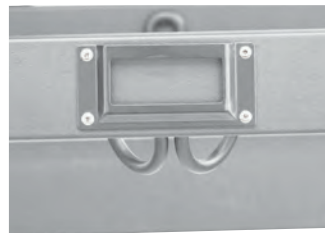

Mobile Knapsack Rack
Name Plate



Mobile Knapsack Rack
Rubber Tip Double Hook

Power Post & Power Port



T-PWR-POST - Power Post



Effortlessly connect the class to technology with versatile power options for tables, café tables, and mobile posts, ideal for media centers, libraries, and collaborative spaces.





T-PWR-POST
Power Post

POWER POST TOP

Frame: 10-Gauge Steel. Black Or Gray Textured Powder-Coated Finish.

Outlets: 8 UL Listed Power Receptacles; 2 Outlets & 2 USB Ports Per Side.

Wire Management: Two Wrap-Around Hooks

Cord: Outlets Are Linked To One Heavy-Duty 133" Cord

Base: 4-Gauge Steel 12" X 12"

Casters: Four 2" Locking Casters

POWER PORTS*

Pop-Up Mechanism: Pop-Up Mechanism Protect By Steel Housing

Power Receptacles

99TT-PWRS-USB: Two USB Receptacles & One UL Listed Power Receptacle

99TT-PWRS-2: Two UL Listed Power Receptacles

*Power Ports must be manufacturer installed.

Connect: Add a power port to any table or teachers desk and charge any electronic device.



99TT-PWRS-2
Power Port



99TT-PWRS-USB
Power Port



99TT-PWRD-RND-USB
Power Port



Power Port

(Shown on CL-2448 - Computer Table with custom Nevamar #WM0047 Tabletop)



Power Port

(Shown on CFSH-3672OV - Standing Ht. Oval Café Table)

Energize your students with a simple power solution.



Power Port

(Shown on 8138-LAM - 30" Round Mod® with Laminate Top)



Mobile Easel

Ht."	W x D"	Model
54"	32 x 25"	7700



Power Post Top

Ht."	W x D"	Model
38"	12 x 12"	T-PWR-POST



Mobile Knapsack Rack

Ht."	W x D"	Model
41½"	38 x 24"	4670



Power Ports

W x D"	Model
5 x 5"	99TT-PWRS-2
5 x 5"	99TT-PWRS-USB
3.5" Dia.	99TT-PWRS-RND-USB-B

Note: Power Ports must be manufacturer installed.





Stay organized by categorizing school and districts into **visual project boards**.



Chat with **Academia's educational specialists**.

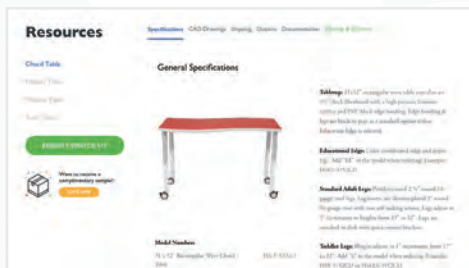

Download, email or save quotes including **specification sheets, cut sheets, product images and CAD drawings**.



Create **budgetary pricing** according to National KPN contract.

Request a Complimentary
SWATCH BOX
 & Product Samples within 48 hours

Desk, Seat, Table, &
 The Mod Series®
 Swatches Available



"Squircle", "The Mod Series" & "Mod" are registered trademarks of Academia Furniture Industries.

www.academiafurniture.com/insights/designers-portal





SCHOOLS WITHOUT WALLS - WASHINGTON, DC



ELEVATE ACADEMY - IDAHO FALLS, ID



MAX LARSEN ELEMENTARY SCHOOL - COLDWATER, MI



AGWSR MIDDLE SCHOOL - WELLSBURG, IA



WEST WHITESBURG ELEMENTARY - WHITESBURG, KY



KIRKWOOD ELEMENTARY SCHOOL - CLARKSVILLE, TN



LE-SUEUR-HENDERSON ELEMENTARY - LE SUEUR, MN



YESHIVA SHAAREITZION - HIGHLAND PARK, NJ



SOMERSET INTERMEDIATE SCHOOL - NORTH PLAINFIELD, NJ



IMAGINE CHARTER SCHOOL AT WESTON - WESTON, FL



DOUGLAS ELEMENTARY SCHOOL - CLINTON, IL



ROSWELL B. MASON ELEMENTARY SCHOOL - CHICAGO, IL



LE-SUEUR-HENDERSON ELEMENTARY - LE SUEUR, MN



FRANKLIN ELEMENTARY SCHOOL - BOONE, IA





BLIND BROOK MIDDLE SCHOOL - RYE BROOK, NY



KIRKLAND RANCH - WESLEY CHAPEL, FL

Seating Caster Guide

Series	Soft Caster	Hard Caster
Chairs: 128C, 126C, Z28C, Z26C, 716C, 718C, 518C	 9SF28W-SC	 STANDARD 9SF28W-C
Computer Chair	 9HF58SC	 STANDARD 9HF58C
Computer Chair Braking Caster	—	 9HF58LC
Mod® Caster	—	 9MOD-CASTER
Mod® Compression Caster	—	 9MOD-CASTER-LOCK

Desk & Table Caster Guide

Series	Soft Caster	Hard Caster
T-Leg Series C-Leg Series	—	 99TW60M
Demonstration Series: STEM Table* STEM Work Station	—	 99TW75- TOTAL LOCK
Synergy Desk Surge Desk Dura Table* Harmony Table Hercules Legs* Illustration V2 Series Petal Series	 99TW75-IL-SOFT	 99TW75-IL-HARD
Nate Double Pedestal Desk	 99NT-LC	—

*Wheelbarrow option available for all adjustable height tables. When ordering wheelbarrow option, order 1 set of casters per 2 tables.

Caster Floor Finish Guide

Floor Type	Soft Caster	Hard Caster
Carpet		•
Hardwood	•	
Polished Concrete	•	
Rubber		•
Tile	•	
Vct(Vinyl)		•

Important Note: Please note that casters add 2-3" to the overall height of the item they are being used with. Example: a desk that is 29" without casters, will be 32" with casters.

Hard casters for soft flooring. Soft casters for hard flooring.

Disclaimer: The following information is offered based on our extensive research and testing. This information is recommended as a guide. It is suggested that the customer does their own research to insure that the glide or caster chosen is the proper selection for their flooring.

Glide Guide

Series	Glide	Nylon	Felt	Rubber	Steel	Extras
Classic Chair Inspiration Chair Hard-Plastic Chair Zed Chair Classic Combos ¹ Standard Desk Activity Tables Café Stools	 Glide shown with Felt Cap	 STANDARD	 9GL-FLT-CVR	 9GL-TPR-CVR	 9GL-STL-CVR	 Felt Snap Cap 9GL-FELT-SNAP
Illustration V2 Desks and Table		 STANDARD	—	 Set of Four 9GL-IL-TPR	—	—
C-Leg Series T-Leg Series		 STANDARD	—	 Set of Four 9GL-TPR	—	—
Sled Base Combos	—	—	—	 Set of Four 9GL-TPR	—	—
Cantilever Chair	 Front Glide Back Glide Color-Coordinated Glides shown with Felt Insert	 Front Inserts: 9GL-IS88-FR-I-NYL Back Inserts: 9GL-IS88-BK-I-NYL	 Front Inserts: 9GL-IS88-FR-I-FLT Back Inserts: 9GL-IS88-BK-I-FLT	 Front Inserts: 9GL-IS88-FR-I-RUB Back Inserts: 9GL-IS88-BK-I-RUB	 Front Inserts: 9GL-IS88-FR-I-STL Back Inserts: 9GL-IS88-BK-I-STL	 Glide Remover for Cantilevered The glide housing and glide inserts have been engineered for easy replacement of worn out inserts. The inserts are designed to mold to flooring and are tamper proof.
Innovation Desk	 Glide shown with Felt Insert	 9GL-I-B-NYL 9GL-I-G-NYL	 9GL-I-B-FLT 9GL-I-G-FLT	 9GL-I-B-RUB 9GL-I-G-RUB	 9GL-I-B-STL 9GL-I-G-STL	—
Computer Chair Series ²		 Set of Five 9HFSG	 9GL-SG-U-FLT	 9GL-SG-U-TPR	 9GL-SG-U-STL	—

Glide Floor Finish Guide

Floor Type	Nylon	Felt	Rubber	Steel
Carpet	•			•
Hardwood		•		
Polished Concrete	•	•		•
Rubber	•		•	
Tile	•	•	•	
Vct(Vinyl)	•	•	•	

¹ Excluding Sled Base Combination Desks

² The options shown are only if stationary bell glides are requested. Standard, the chair ships with casters.

Disclaimer: The following information is offered based on our extensive research and testing. This information is recommended as a guide. It is suggested that the customer does their own research to insure that the glide or caster chosen is the proper selection for their flooring.

Woodstone & Hard Plastic



Woodstone Desktops offer a whole new level of durability, strength, convenience and value.

Woodstone is a mixture of wood fibers and melamine resin, with a laminate finish –baked at 308°F under high pressure.

Lighter: They are 10% lighter than a Hard Plastic Desktop

Affordable: Woodstone Desktops cost about 18% less than conventional hard plastic.

Reliable: Woodstone exceeds ANSI/BIFMA requirement on 5 rigorous tests!



Hard Plastic desktops are solid plastic manufactured with ground hardwood floor, color pigment and melamine plastic resins blended and compressed under heat and pressure to form a homogeneous top.

Classic & Timeless: An all time classic for schools everywhere.

Resilient: Solid Plastic desktops are resilient, heavy-duty and virtually maintenance free.

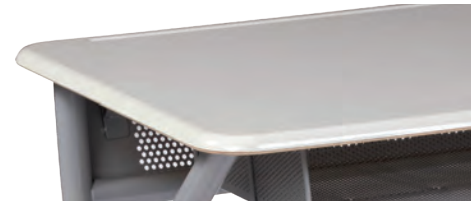

High-Pressure Laminate Edge Finishes



T-MOLD STANDARD

Hydraulically inserted PVC T-Mold edge banding 1/8" thick, bull-nose profile and smooth matte finish.



T-Mold*
(Shown in Primary Red)



X-STRONG OPTIONAL

Sprayed on polyurea, a tough and waterproof textured Epoxy paint, bonded directly onto the table edge, finished with a high lacquer coating.



X-Strong*
(Shown in Tangerine)



PVC 3MM OPTIONAL

3mm thick PVC material applied with heat activated durable adhesive, in a smooth flat matte finish.



PVC 3mm*
(Shown in Aqua)

High-Pressure Laminate Edge Finishes	T-Mold Standard	X-Strong Optional	PVC 3mm Optional
Student Desk, Classroom Table and Café Table	•	•	•
Combo Desk	•		
Teacher Desk: Nate Stations/Desks and Petal Lazer			•
Teacher Desk: Vantage and Kinect	•		
Study Carrel			•

*Edge Finishes are available in standard Black and Light Gray, and in all Educational Edge colors

Colors shown in this printed catalog may vary slightly from actual product due to aging, lighting, and printing process. For accurate color representations request a complimentary physical swatch.



Desktop Options



Rectangular

(Available in all colors)



Tablet-Arms
Standard & Jumbo Top

(Available in Gray Nebula, Light Gray, Beige, and Light Oak)



Arc-Shaped

(Available in Gray Nebula, Light Gray, Beige, Light Oak Cherry and Driftwood)

Woodstone Desktop Colors

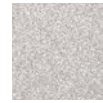

Gray Nebula



Light Gray

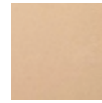

Beige



Fusion Maple



Light Oak



Cherry



Driftwood



Desktop Options



Rectangular

(Available in all colors)



Tablet-Arms
Standard & Jumbo Top

(Available in Gray Nebula, Light Gray, Beige, and Bannister Oak)



Innovation

(Available in Gray Nebula, Fusion Maple, Bannister Oak, Wild Cherry, Driftwood and Sky Rise)



Petal Series

(Available in Gray Nebula, Light Gray, Fusion Maple, Bannister Oak, Wild Cherry, Driftwood and Sky Rise)

Hard-Plastic Desktop Colors

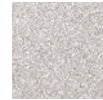

Gray Nebula



Light Gray



Beige



Fusion Maple



Bannister Oak



Wild Cherry



Driftwood
NEW



Sky Rise
NEW

Desktop, Tabletop and Laminate Surface Options

New Standard Formica Laminate Colors



Stop Red



New Burgundy



Cassis



Spectrum Blue



Spectrum Green



Vibrant Green



Clementine



Chrome Yellow



Brite White



Sheer Fabric



Oyster Gray



Neutral Twill



Gray Fabric



Origami Paperfold



Fog



Buff Elm



Swede Rift Oak



Washi Paperfold



Chambray Fabric



Mouse



Millennium Oak



Taupe Walnut

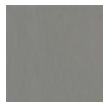

Stainless



Weathered Ash



Camel Elm



Silver Riftwood



Storm



Graphite

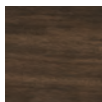

Antique Mango



Graphite Twill



Black Riftwood



Graphite Grafix

White Board: Warranty and proper care information can be found on our price list or by contacting your local dealer.
White Markerboard is NOT standard for Nate Teacher Desks, Study Carrels, Bookcases, STEM Workstation Cabinet and Tote Bin Cabinet.

Standard Laminate Colors



White Board



Sky Rise

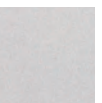

Gray Nebula



Fusion Maple



Enrich



Bannister Oak

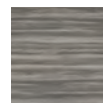

Driftwood



Wild Cherry

Standard Frame Finishes

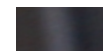

Black



Tungsten Gray

Educational Edge / Upper Leg Colors



Primary Red



Burgundy



Purple



Primary Blue



Navy



Ocean Blue



Aqua



Primary Green



Lime Green



Tangerine



Sunshine Yellow



Graphite

Enhance the way students learn by color coordinating the edges, upper legs and book boxes.

Standard Edge Banding & Upper Leg*



Black



Light Gray

*Only for Tables and Student Desks

Colors shown in this printed catalog may vary slightly from actual product due to aging, lighting, and printing process. For accurate color representations request a complimentary physical swatch.

Seat Options

Seat Shapes



Adj. Ht. Squirrel® Stool



Fix. Ht. Squirrel® Stool

Squirrel® Stool Colors



Zed Seats

Inspiration Seats

Classic Seats

Zed, Inspiration & Classic Chair Seat Colors



Hard-Plastic Seats

Hard-Plastic Seat Colors



Seating Frame Options

Chair Frame Finish



Chrome



Gray (G) Powder Coating**



Black (B) Powder Coating**

**Powder Coating: Only available for Zed Chair. Not available with Bookbasket (WBB), Computer Chair and Drafting Stool.

Tote Bins



Gray or Clear Tray

Standard Colors



9CRTWD-SLIM TRAY-M Matte Colored Tray

Primary Colors (Upcharge)



Pastel Colors (Upcharge)

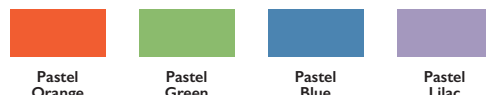

9CRTWD-SLIM TRAY-C Crystal Tinted Blue

Crystal Colors (Upcharge)

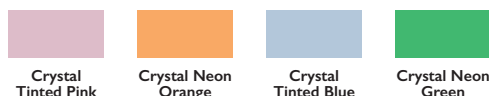

Colors shown in this printed catalog may vary slightly from actual product due to aging, lighting, and printing process. For accurate color representations request a complimentary physical swatch.

Chairs



Pads (Must be manufacturer installed)

Computer & Seminar Table Accessories

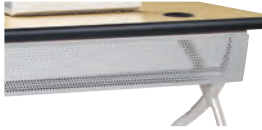

Wire Management for V2 Illustration (99V2-MP36-72)



Wire Management End Cap for Illustration V2 Tables only (99IL-MP-CAP)

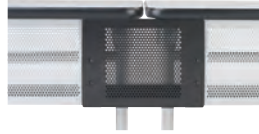

Connector Bridge for V2 Illustration (99IL-MP-Bridge)



Connector Bridge for C-Leg Series Only (99-MP-Bridge)



Standard Keyboard (Key) 20"W x 11"D



Standard Keyboard with Mouse Pad (KEY-F312) 20"W x 11"D Mouse is 9" Round



T-Leg Wire Management (WM36-72)



Grommets (99GC)



Table Hook for All Except V2 Series (9TAB-HOOK)

Size Chart

Number of Computer Workstations Per Table

Table Width	1 CPU	2 CPUs	3 CPUs
36"	•		
48"	•	•	
60"	•	•	
72"	•	•	•

Desk Accessories

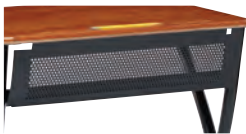

Illustration V2 Modesty Panel (9DF27-MP)



Pencil Drawer for Single & Double Pedestal (99NT-PENCIL)



Cup Holder (99-CUPHOLDER)



Innovation, Petal, and Surge Series Hooks (9TRI-Hook)



Illustration V2 Backpack Hooks (9DF27-BKHK)

Book Boxes



Innovation Mesh Book Box (9TRI-BKXB) 17"W x 12"D x 4"H //3.5WT



Innovation Wire Book Box (9TRI-WBR) 17"W x 14"D x 4"H //2.5 WT



Steel Book Box for T-Leg and Double Desks (99DDMBB-B) 18"W x 16"D x 5"H //5WT



Petal & Jr Petal Mesh Book Box (9DF1950-MBB) 17"W x 12"D x 4"H //3.5WT



Illustration V2 and Surge Mesh Book Box (9DF17-MBB) 17"W x 12"D x 4 1/2"H //4WT



Plastic Tray (9THINBIN) for Surge, Junction, Synergy, Synco Desks and Hercules, Activity Leg, Forte Tables

Colors shown in this printed catalog may vary slightly from actual product due to aging, lighting, and printing process. For accurate color representations request a complimentary physical swatch.

Academia

FURNITURE INDUSTRIES

74 S. Passaic St. Wood-Ridge, NJ 07075
973-472-0100 • academiafurniture.com

