



Academia

FURNITURE INDUSTRIES



School Furniture Catalog

We Manufacture Quality **Classroom Furniture**

Excellent Design, Durability, Service and Pricing

Promise & **Philosophy**

Our Promise: To exceed your expectations in innovative classroom furniture by personally and helpfully servicing your every need promptly in a true relationship-based association.

Our philosophy: To provide what we promise, when we promise, at a competitive price.

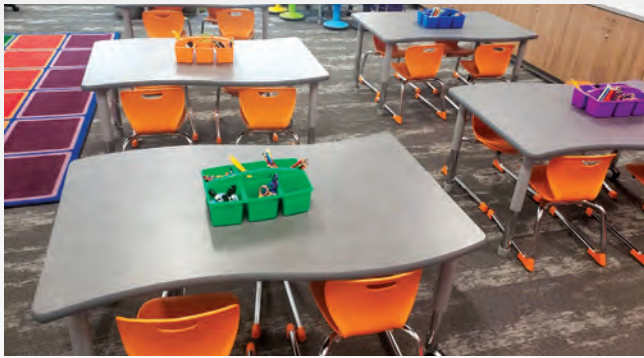

We Design **Innovative Products**

Making you look good makes us proud. Design, safety, utility, comfort, stability, and durability are just the start. Colors, shapes, sizes, finishes, gliding or immobile - the choices abound.

From prestigious public schools to new charter schools, students, teachers and administration are delighted with Academia's quality and versatility. Let's see how good we can make you look.

Environmentally **Conscious**



Earning 100% compliance with the most stringent standards by recognized independent testing agencies, Academia goes further by reducing our environmental footprint and constantly testing to ensure that all products are classroom-safe and kid-friendly (MAS Certified Green and LEED compliant)



15-Year **Warranty**

Academia Furniture Industries offers the original user a limited fifteen-year warranty against all manufacturing defects in material and workmanship from date of purchase.

New Featured Items

SCHOOL SEATING

Squirrel®
Page 16



CLASSROOM TABLE
Hercules Curved

Table
Page 70

MEDIA CENTER
STAX Curved
Bookcase
Page 98

STUDENT DESK

Junction Desk
Page 22



CLASSROOM TABLE

Hercules Sushi
Table
Page 70



MEDIA CENTER
Pebble Mod®
Page 94

CLASSROOM TABLE

Demonstration
STEM Workstation
Page 82



MEDIA CENTER
The Mod Series®
Page 94



SCHOOL SEATING 4-17

Zed Series- School Chair.....6-7
 Inspiration Series - School Chair8-9
 Classic Series - School Chair.....10-11
 Hard Plastic Series - School Chair.....12-13
 Educational Series - Lab Stool.....14-15
 Squirrel® – Active Seating Stool.....16-17

COLLABORATIVE STUDENT DESK 18-31

S4 Desk- School Desk.....20-21
 Junction Desk- School Desk.....22-23
 Synergy - School Desk.....24-25
 Innovation Series - School Desk.....26-27
 Petal Series - School Desk.....28-29

TRADITIONALLY MODERN STUDENT DESK 32-45

Surge Series - School Desk.....32-33
 Illustration V2 Series - School Desk.....34-35
 T-Leg Series - School Desk.....36-37
 Standard Series - School Desk with Plastic Bookbox.....38-39
 Standard Series - School Desk with Metal Bookbox.....40-41
 Standard Series - Open-View/Writing/Wheelchair School Desk.....42-43
 Double Desks.....44-45

COMBO DESK..... 46-59

Unity Study - School Combo Desk.....48-49
 Inspiration Series - School Combo Desk.....50-51
 Classic Series - School Combo Desk.....52-53
 Hard-Plastic Series - School Combo Desk.....54-55
 Hard-Plastic Series - Braced School Combo Desk.....56-57
 Classic & Hard-Plastic Series - School Tablet-Arm Combo58-59

TEACHER DESK 60-67

Nate Series - Teacher Station.....60-61
 Nate Series - Teacher Desk.....62-63
 Petal Series - Lazer Teacher Desk.....64-65
 Vantage Series - Teacher Desk.....66-67

CLASSROOM TABLE 68-89

Hercules Series - Group-Study and Activity Table.....70-71
 Harmony Series - Group-Study and Activity Table.....72-73
 Dura Series - Collaborative and Group Study Table.....74-75
 Activity Series - Group-Study and Activity Table.....76-77
 Demonstration Series - STEM Table.....80-81
 Demonstration Series - STEM Work Station.....82-83
 Illustration V2 Series - Computer and Seminar Table.....84-85
 C-Leg Series - Computer Table.....86-87
 T-Leg Series - Computer and Seminar Table88-89

MEDIA CENTER 90-107

Student Lounge – The Mod Series®.....92-95
 STAX- Curved Bookcases.....98-99
 STAX Bookcase - Single and Double Sided Bookcase.....100-101
 Boost Series - Café Tables & Stool104-105
 Study Carrel Series - Study Carrel.....106-107

ESSENTIALS 108-109

Mobile Easel.....108
 Power Post Top / Power Ports.....109

INSTALL SHOWCASE 110-111

GUIDES 112-117

Caster & Glide Guide.....112-113
 Woodstone & Hard Plastic / Designers Corner114
 Desktop Color and Finish Options.....115
 Seat Options.....116
 Accessories.....117

SCHOOL SEATING



MEADOWLARK ELEMENTARY SCHOOL - SALT LAKE CITY, UT



Zed Series – Cantilever Chairs & Computer Chairs
Harmony Series – Chord and Rhythm Tables
Innovation Series – School Desks

SCHOOL SEATING

Zed Series – School Chair



Z68 - Cantilever Chair



DESIGN

Created to answer every education seating need, based on extensive research.



COMFORT

Extreme comfort, striking contours and sleek, extra-wide back and seat / fits all children and adults.



STRENGTH

Astounding hybrid engineering -- injection & blow mold -- minimizes internal stress for longest wear.



BENEFITS

Gas-assisted injection produces lightweight, blemish-free, cosmetically perfect surface.

Zed Series – School Chair



Z18 - Standard Chair



Z28 - Value Chair



Z28C - Value with Casters



Z68 - Cantilever Chair



Z58 - Computer Chair

- Built-In Carry Handle
- Shell: Color-Impregnated Polypropylene Injection and Gas Assist Molded Plastic.
- Smooth and Secure Shell Back
- Frame: 1" Round, 16-Gauge Steel
(Available in Chrome-Plated, Gray (G) Powder Coating* or Black (B) Powder Coating*)
- Boots: Color-Impregnated Polypropylene Plastic
(Standard Chair Only)
- Self-Adjusting Nylon Glides



Model	Seat Height"	W × D"
Standard	Value	
Z12	Z22	12" 12¾ × 12"
Z14	Z24	14 12¾ × 12"
Z16	Z26	16 17 × 16"
Z18	Z28	17¾ 17 × 16"
Z19	Z29	18¾ 17 × 16"
—	Z26C	16 17 × 16"
—	Z28C	18 17 × 16"

Bookbasket (WBB)*: Chrome-plated ¼" rod steel: 14½"W × 12"D × 8"H. To request, add "WBB" to the model when ordering. **Example:** Z18WBB
Bookbasket must be installed by manufacturer.

Model	Seat Height"	W × D"
Cantilever Chair		
Z62	12"	12¾ × 12"
Z64	14	12¾ × 12"
Z66	16	17 × 16"
Z68	18	17 × 16"
Z69	19	17 × 16"

Cantilever Chair Frame: Features 12-gauge steel leg. Rubber bumpers to protect and grip the table top.

Cantilever Chair Glides: Color coordinated injection molded sled base glide housing to accommodate a choice of four glide inserts; nylon, felt, steel or rubber. Select finish at the time of ordering.

Model	Seat Height"	W × D"
Computer Chair		
Z58	17-23"	17 × 16"
Drafting Stool		
Z58D	24-33"	17 × 16"

Gray Powder Coating (G)*: To request, add "G" to the model when ordering. **Example:** Z18G

Black Powder Coating (B)*: To request, add "B" to the model when ordering. **Example:** Z68B

Optional Items: Glide Caps (Felt, Rubber and Steel), Stationary Bell Glides (for 5-Star Swivel Computer Chairs) can be requested instead of Casters at the time of ordering.

*Powder Coating is not available on models with Bookbasket (WBB), Computer Chair and Drafting Stool. All heights listed are within ¾" variants.

- Pneumatic Lift
- Adjustable Gas Lift Cylinder
- Chrome-Plated Foot Ring
- 5-Star Plastic Swivel Base On Five Casters



Z58D - Drafting Stool

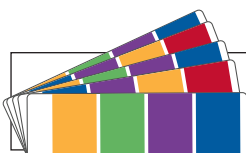

Colors, Guides, & Accessories
See pages 112-117

Inspiration Series – School Chair



688 - Cantilever Chair



Flex of Back

Underseat Rivets



Carry Handle



Back with Ribs



DESIGN

This design incorporates the latest looks, trends and colors to enhance any modern classroom environment. Stackable to eight chairs high.



COMFORT

The dual curves and flex action of the back provide exceptional support.



STRENGTH

16-gauge steel mated to strong, yet flexible polypropylene plastic shells, capped off with self-adjusting glides with nylon inserts.



BENEFITS

From the built-in carry handle, to the chrome-plated steel to the color-coordinated boots, these chairs truly are an Inspiration.

Inspiration Series – School Chair



618 - Standard Chair



718 - Value Chair



718C - Value Chair with Casters



718SB - Sled Base Chair



658X - Computer Chair
(Shown with optional stationary bell glide)



658D - Drafting Stool

Model	Seat Height"	W x D"
Standard	Value	
612	712	11½" 12¼ x 12"
614	714	13½" 12¼ x 12"
616	716	16¼" 16 x 16"
618	718	17¾" 16 x 16"
618X	718X	17¾" 17¾ x 16"
619	719	19" 16 x 16"
619X	719X	18½" 17¾ x 16"
—	716C	16¼" 16 x 16"
—	718C	19½" 16 x 16"
—	718SB	18" 16 x 16"

Bookbasket (WBB): Chrome-plated ¼" rod steel: 14½"W x 12"D x 8"H. To request, add "WBB" to the model when ordering. **Example:** 618WBB
Bookbasket must be installed by manufacturer.
Sled-Base: 16 - gauge chrome-plated steel.

Model	Seat Height"	W x D"
Computer Chair		
658	17-23"	16 x 16"
658P	17-23"	16 x 16"
658X	17-23"	17¾ x 16"
Drafting Stool		
658D	24-33"	16 x 16"
658XD	24-33"	17¾ x 16"

X-Plus(X): Larger shell and Frame for added weight capacity available.

Pads: Available on chairs 16" and above. Only available colors are Black, Burgundy, and Navy. Add "P" to the model when ordering. **Example:** 618P

Optional Items: Glide Caps (Felt, Rubber and Steel), Stationary Bell Glides (for 5-Star Swivel Computer Chairs) can be requested instead of Casters at the time of ordering.

All heights listed are within ¼" variants.

Model	Seat Height"	W x D"
Cantilever Chair		
682	12"	12¼ x 12"
684	14"	12¼ x 12"
686	16¼"	16 x 16"
688	18"	16 x 16"
688X	18"	17¾ x 16"
689	19"	16 x 16"
689X	19½"	17¾ x 16"

Cantilever X-Plus: Cantilever X-Plus legs feature a ¾" steel tube and larger shell for added support.

Cantilever Chair Frame: Features 12-gauge steel legs.

Cantilever Chair Glides: Color coordinated injection molded sled base glide housing to accommodate a choice of four glide inserts; nylon, felt, steel or rubber. Select finish at the time of ordering.

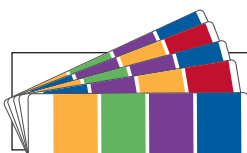

Colors, Guides, & Accessories
See pages 112-117

SCHOOL SEATING

Classic Series – School Chair



128 - 18" Classic Chair



Steel Back Supports



Waterfall Edge Front



Full-Contact Welds

14-Gauge Underseat Steel



COMFORT

Our classic school chair offers a waterfall seat with a curved back, supporting students of all sizes.



DESIGN

In any classroom old or new, our curved seat and vented back offer a timeless design.



BENEFITS

Heaviest polypropylene shell, 1½" round, 18-gauge chrome-plated steel (1" round for 12" and 14" chairs), available in five sizes. Self-adjusting, nickel-plated glides with nylon inserts.



STRENGTH

Side by side tubular steel back supports, seatback ribs and 14-gauge underseat brackets.

Classic Series – School Chair



128WBB - Chair with Bookbasket



128C - Chair with Casters



128M - Music Chair



128SB - Sled-Base Chair



158P - Computer Chair with Pads

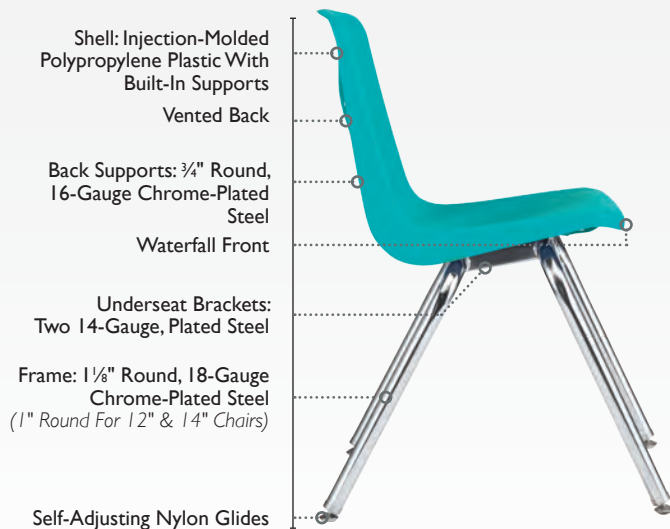

Model	Seat Height	W x D"
Standard		
122	11 3/4"	13 x 12"
124	14	13 x 12
126	16 1/2	16 1/4 x 15
128	18 1/4	16 1/4 x 15
129	19 1/4	16 1/4 x 15

Casters		
126C	16"	16 1/4 x 15"
128C	18	16 1/4 x 15

Music Chair		
128M	17 3/4"	16 1/4 x 15"

Bookbasket (WBB): Chrome-plated 1/4" rod steel: 14 1/2"W x 12"D x 8"H. To request, add "WBB" to the model when ordering. **Example:** 128WBB

Bookbasket must be installed by manufacturer.

Model	Seat Height"	W x D"
Sled Base		
128SB	18"	16 1/4 x 15"

Sled Base Frame: 3/4" round 16-gauge chrome-plated steel.



Model	Seat Height"	W x D"
Computer Chair		
158	17-23"	16 1/4 x 15"
158P	17-23"	16 1/4 x 15

Drafting Stool		
158D	24 1/2-29 1/2"	16 1/4 x 15"
158PD	24 1/2-29 1/2"	16 1/4 x 15

Pads: Available on chairs 16" and above. Available colors are Black, Burgundy, and Navy. Add "P" to the model when ordering. **Example:** 128P

Optional Items: Glide Caps (Felt, Rubber and Steel), Stationary Bell Glides (for 5-Star Swivel Computer Chairs) can be requested instead of Casters at the time of ordering.

All heights listed are within 3/4" variants.

158D - Drafting Stool

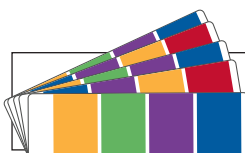

Colors, Guides, & Accessories
See pages 112-117

SCHOOL SEATING

Hard Plastic Series – School Chair



518 - 18" Hard Plastic Chair



COMFORT

The contoured seat is shaped to follow natural body lines while the back is designed to support your students where they need it.

BENEFITS

The gooseneck-shaped chair back is designed for optimal back support and for secure upside-down stacking on desks.

STRENGTH

The 14-gauge steel back support (16-gauge on the 10", 12" and 14") and 16-gauge steel legs mated to $\frac{3}{8}$ " thick hard-plastic seat and back make this our strongest chair available.

DESIGN

This traditional design has been a staple of classrooms nationwide for more than 40 years. Designed to be stacked up to five chairs high for easy storage.

Hard Plastic Series – School Chair



518WBB - Chair w/Bookbasket



518XBR - Chair w/X-Brace



518C - Chair w/Casters



558 - Computer Chair

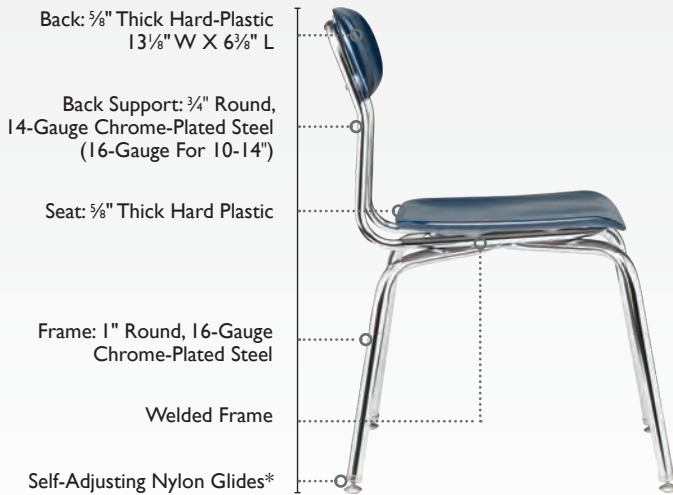

Model	Seat Height"	W x D"
Standard		
510A	12 1/2-15 1/2"	13 1/2 x 13"
512	12	13 1/2 x 13
514	14	13 1/2 x 13
516	15 3/4	15 3/4 x 15
518	17 3/8	15 3/4 x 15
519	18 3/8	15 3/4 x 15
Casters		
518C	18 3/8"	15 3/4 x 15"

Bookbasket (WBB), and X-Brace (XBR) must be installed by manufacturer.

Bookbasket (WBB): Chrome-plated 1/4" rod steel: 14 1/2" W x 12" D x 8" H. To request, add "WBB" to the model when ordering. **Example:** 518WBB

X-Brace (XBR): Chrome-plated 3/8" X rod steel. To request, add "XBR" to the model when ordering. **Example:** 518XBR. Not available in 10" & 12" Chairs.



558D - Drafting Stool

Model	Seat Height"	W x D"
Computer Chair		
558	17-23"	15 3/4 x 15"
Drafting Stool		
558D	24 1/2-29 1/2"	15 3/4 x 15"

Optional Items: Glide Caps (Felt, Rubber and Steel). Stationary Bell Glides (for 5-Star Swivel Computer Chairs) can be requested instead of Casters at the time of ordering.

All heights listed are within 3/4" variants.

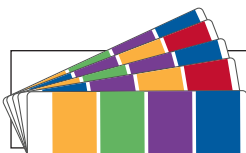

Colors, Guides,
& Accessories
See pages 112-117

Educational Series – Lab Stool



4518A - Hard-Plastic Stool



Welds at Foot Ring

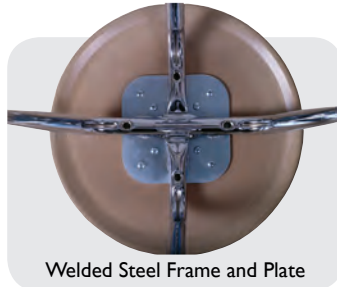

Welded Steel Frame and Plate

STRENGTH

The 13" diameter hard-plastic seats are screwed to large underseat plates which are welded to the frame for years of secure seating.

BENEFITS

Designed for environments such as science labs, kitchens and art rooms, their strength, stability and easy-clean surface make them a perfect fit.

DESIGN

Our current design features a wider footprint for added stability.

COMFORT

Students are sure to find a comfortable position since these stools are available with fixed or adjustable height legs.

Educational Series – Lab Stool



4518A - Hard Plastic Adjustable Height Stool



4530 - Fixed Height Stool



4518AWB - Adjustable Height Stool with Back Support



4530WB - Fixed Height Stool with Back Support

Seat: 5/8" Thick Hard-Plastic
13" Diameter

Frame: Chrome-Plated 7/8"
18-Gauge

Foot Ring:
18-Gauge 3/4" Outer-Diameter

Self-Adjusting Nickel-Plated
Casing With Nylon Inserts



4518A - Hard Plastic Adjustable Height Stool

Model Seat Height" Base W x D"

Hard Plastic

4518A	18-26"	14 x 14"
4518F	18	14 x 14
4524	24	16 x 16
4530	30	18 x 18

Back: 5/8" Thick Hard-Plastic
13 1/8"W x 6 3/8"L

Back Support: 3/4" Round,
14-Gauge Chrome-Plated Steel
Welded To Bottom Frame

Frame: 3/4" 18-gauge
Two Self-locking Screws
18-27" Adjustable Height
(4518A & 4518AWB only)



4518AWB - Adjustable Height Stool with Back Support

Model Seat Height" Base W x D"

Seat Back

4518AWB	18-24"	14 x 14"
4518FWB	18	14 x 14
4524WB	24	16 x 16
4530WB	30	18 x 18

Optional Items: Glide Caps (Felt, Rubber and Steel).

All heights listed are within 3/4" variants.

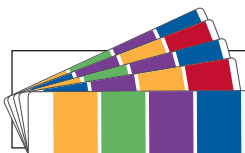

**Colors, Guides,
& Accessories**
See pages 112-117

Squircle® – Active Seating Stool



SQ-18 - Active Seating Stool

Waterfall Edge Seat
Doubles as Grab Handle



Rubber Base Shaped
to Wobble



Comfortable Foam Center

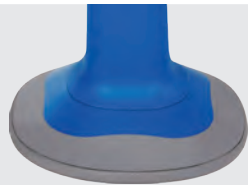

Rubber Overmold for
Nonslip Surface

STRENGTH

Rubber base shaped to wobble, not topple. Ensures feet rest firmly on chair. Nonslip protection for any weight- both for students and adults.

BENEFITS

Waterfall edge seat doubles as grab handle; lightweight for easy mobility; soft, durable foam seat; created to relieve muscles from hours of sitting.

DESIGN

The Squircle® allows students to safely release energy with a unique dome base angled to sway securely in every direction.

VERSATILITY

Appealing addition to any learning environment: desks, tables, reading or lounge areas. 13 color options and 3 height options: 13, 15 and 18 inches.

Squircle® – Active Seating Stool



SQ-18 & HS-3152CD - **Active Seating Stool & Harmony Chord Table**
(Shown with custom Gray Graphite Chem Res HPL)



SQ-18 & HL-4848SQ - **Active Seating Stool & Hercules Square Table**
(Shown with custom Gray Graphite Chem Res HPL and X-Strong Edge)



SQ-18 - **Active Seating Stool**

Model	Seat Height"	Base W × D"
Active Seating Stool		
SQ-13	13"	13 × 13"
SQ-15	15	13 × 13
SQ-18	18	13 × 13

All heights listed are within ¼" variants.
"Squircle" is a registered trademark of Academia Furniture Industries.

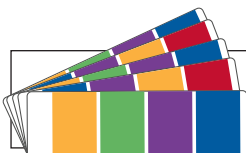

**Colors, Guides,
& Accessories**
See pages 112-117

STUDENT DESK



DR. KIRAN C. PATEL HIGH SCHOOL - TAMPA, FL



Zed Series – Cantilever School Chair & Drafting Stool
Petal Series – School Desk
Surge Series – School Desk
Dura Series – Adam Table

S4 Stacking Series – School Desk



4429 - S4 Student Desk



Concave and Convex Sides



Fully Unitized Frame

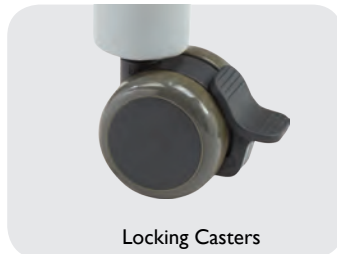

Locking Casters



VERSATILITY

Stacks 4 high with locking casters and glides for quick rearranging or clean-up. Students, teachers and maintenance staff can easily move the space-saving stacks.



BENEFITS

Extra large work surface allows 2 students to share one desk or combine 2 (no gap!) facing each other both ways.



DESIGN

Concave and Convex sides offer various configurations for collaborative work study. Arched row of 8 provides full visibility for panels and presenters.



STRENGTH

Fully unitized frame guarantees years of strong usage. High Pressure Laminate surface (6 standard colors or hundreds of HPL custom colors for desktop, 13 edge band colors).

S4 Stacking Series – School Desk



4429 - S4 Student Desk Stacked



4429 - S4 Student Desk Group of 4

520 Sq. Inch Work Surface
 Desktop: Fiberboard
 5/8" Thick High Pressure
 Laminate
 29"W x 20"D

A Unique Collaborative
 Style Desktop

Utilized Frame:
 1 1/2" Steel Round 17 Gauge
 Legs With 17 Gauge Upper
 Frame.

The desk's frame features 6
 protective bumpers to avoid
 any scratches for safe stacking.

2" Locking Casters

Wheelbarrow Style Legs with
 Ht. Adj. Nylon Glide



Model	Desk Height"	W x D"
High Pressure Laminate		
4429	29 1/4"	29 x 20"
4400A	26-36	29 x 20"

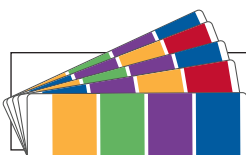
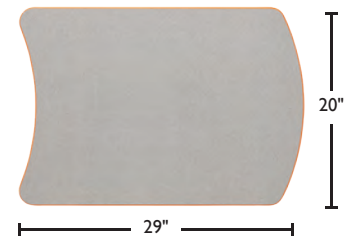

Colors, Guides,
 & Accessories
 See pages 112-117

Junction – School Desk



5300 - Junction Desk
(Shown with laminate Driftwood, Lime Green Educational Edge color, optional Casters & Mesh Bookbox)



Adjustable Legs Compatible with Casters or Glides



Heavy Duty Support Plate



Ample Work-Surface



VERSATILITY

Book basket accessible in any arrangement; height adjustable from K-12; individual use and pods of 3 or 4; many color options.



BENEFITS

Total usable work area, both collaboratively or alone; intuitive to pod in configurations of 3 or 4.



STRENGTH

T-molded edges, structured to withstand years of reconfiguring, choice of casters or glides.



DESIGN

Precisely designed as the ultimate pod desk - maximizes work surface, minimizes floor space.

Junction – School Desk

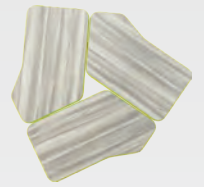

Pod of 3



Pod of 4

5300 - Pod of 3 & 4 Desks
(Shown with laminate Driftwood, Lime Green Educational Edge color, optional Casters & Mesh Bookbox)

- 643 Sq. Inch Work Surface
- Desktop: 1½" Thick High Pressure Laminate
- PVC Edge Banding
- Educational Edge (EE)* is optional*
- Desk Supports: Powder Coated ¾" Square 18 Gauge Steel Tubing
- Upper Legs: Powder-Coated 2½" Round 18-Gauge Steel
- Two Self-Locking Screws
- Insert Legs: Chrome-Plated 2" Round 16-Gauge Steel
- Compatible with Ht. Adj. Glides (Standard) or Casters (Optional)
- Legs Adjust In 1" Increments



5300 - Junction Desk

Model	Desk Height"	W × D"
Standard		
5300	23-32"	35.1 × 21.7"
5300EE	23-32"	35.1 × 21.7"
Toddler Height		
5300S	17-22"	35.1 × 21.7"
5300EES	17-22"	35.1 × 21.7"
Standing Height		
5300SH	26-42"	35.1 × 21.7"



Optional Items: Hard and Soft Casters, Mesh Bookbox, Backpack Hook.

Standing Height Legs: Available in Black or Tungsten Color.

*Educational Edge (EE) for Desks is a color coordinated edge banding and legs. Note the color needed when ordering.

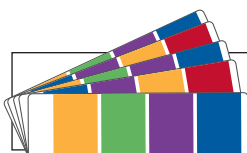

Colors, Guides,
& Accessories
See pages 112-117

Synergy – School Desk



5200 - Synergy Desk
 (Shown with custom laminate Wilsonart Ocean #D502, optional Backpack Hook, Casters & Mesh Bookbox)



Adjustable Legs Compatible with Casters or Glides



Heavy Duty Support Plate



Ample Work-Surface



VERSATILITY

Synergy is the ultimate in collaborative seating options. These desks can be individual or combined in pods of 2, 3, 4 or 5.



BENEFITS

Adjustable heights accommodate K-12. Sturdy, smooth surface cleans in a cinch.



STRENGTH

Your choice of casters or glides easily rearranges for years of various grouping needs. Reinforcing supports add greater durability.



DESIGN

Artistic profile stands gracefully alone; fits together to form stylish shapes for student collaboration, with or without teacher supervision.

Synergy – School Desk

Space Saver

Synergy's multi-shaped options maximize collaborative workspace, while minimizing occupied classroom space.



Pod of 3
31 sq. ft of
classroom space



Pod of 4
35 sq. ft of
classroom space



Pod of 5
40 sq. ft of
classroom space



Pod of 6
44 sq. ft of
classroom space



5200 - Pod of 6 Desks
(Shown with Standard White Board and custom laminates Wilsonart Ocean #D502, Formica Amarena #6907, Spectrum Blue #851, Mouse #928 as well as optional Casters)

- 681 Sq. Inch Work Surface
- Desktop: 1 1/8" Thick High Pressure Laminate
- PVC Edge Banding
Educational Edge (EE) is optional*
- Desk Supports:
Powder Coated 3/4" Square
18 Gauge Steel Tubing
- Upper Legs: Powder-Coated
2 1/8" Round 18-Gauge Steel
- Two Self-Locking Screws
- Insert Legs: Chrome-Plated 2"
Round 16-Gauge Steel
- Compatible with
Ht. Adj. Glides (Standard) or
Casters (Optional)
- Legs Adjust In 1" Increments



5200 - Synergy Desk

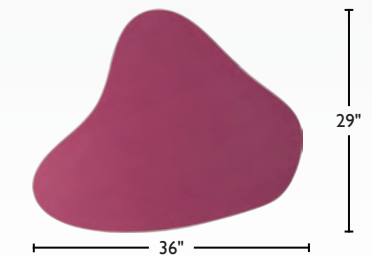

- Standing Height Legs: Available
in Black or Tungsten Color
- Legs Adjust In 1" Increments



5200SH - Synergy Standing
Height Desk



Need help configuring in groups?
Request a complimentary
puzzle set.

Optional Items: Hard and Soft Casters,
Mesh Bookbox, Backpack Hook.

Standing Height Legs: Available in Black
or Tungsten Color.

*Educational Edge (EE) for Desks is a color
coordinated edge banding and legs. Note the
color needed when ordering.

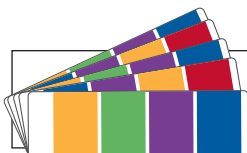

**Colors, Guides,
& Accessories**
See pages 112-117

Innovation Series – School Desk



Matching Options



Power Post
See page 109

2000 - **Innovation Desk**
(Shown with custom laminate Wilsonart Flamingo #D497, optional Backpack Hook and Mesh Bookbox.)



Unitized Frame

 **COMFORT**

The modern design offers ample legroom, perfect for students of any size.

 **DESIGN**

Triangular desktop provides adaptability for multiple configurations.

 **BENEFITS**

Over 350 square inches of desktop space, plus two pencil grooves.

 **STRENGTH**

Unitized steel frame provides stability in any formation.



Optional Mesh Bookbox



Optional Back Pack Hook

Innovation Series – School Desk



2000 - Innovation Desks Pod



Right-Handed Position



Forward Facing Position



Left-Handed Position

(Shown with custom laminate Wilsonart Island #D498)

- 533 Sq. Inch Work Surface
- Desktop: 1 1/8" Thick High Pressure Laminate
- Frame: Unitized Triangular Powder-Coated Steel 3/4" Square Tube, 18-Gauge
- Upper Legs: Powder-Coated 1 3/8" Round 18-Gauge Steel
- Two Self-Locking Screws
- Insert Legs: Chrome-Plated 1 1/4" Round 16-Gauge Steel
- Poly Propylene Height Adjustable Glides
- Legs Adjust In 1" Increments



2000 - Innovation Desk

Model	Desk Height"	W x D"
Innovation Desk		
2000	23-33"	36 x 28"
2000HP	23-33"	36 x 28"

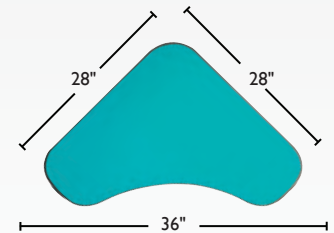

- Standing Height Legs: Available in Black or Tungsten Color
- Brace: 3/4" Round 18-Gauge Steel Adjusts From 10-12"
- Legs Adjust In 1" Increments



2000SH - Innovation Standing Height Desk
(Shown with custom laminate Wilsonart Ocean #D502)

Model	Desk Height"	W x D"
Innovation Standing Height Desk		
2000SH	31-43"	36 x 28"
2000HPSH	31-43"	36 x 28"

Optional Items: Backpack Hook, Glide Inserts (Nylon, Felt, Steel or Rubber), Mesh Bookbox, Wire Bookrack, Power Post, Ganging, Glide Insert Replacements.

Standing Height Legs: Available in Black or Tungsten Color.

Hard-Plastic Desktop Colors: Not Available in Light Gray and Beige.

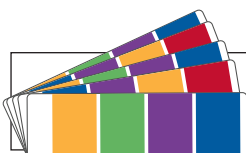

Colors, Guides, & Accessories
See pages 112-117



See pages 114

Petal Series – School Desk



1950EE - Junior Petal Desk
(Shown with optional Casters and Mesh Bookbox)

Matching Options



Lazer Teacher Desk
See page 64-65



Hercules Tables
See page 70-71

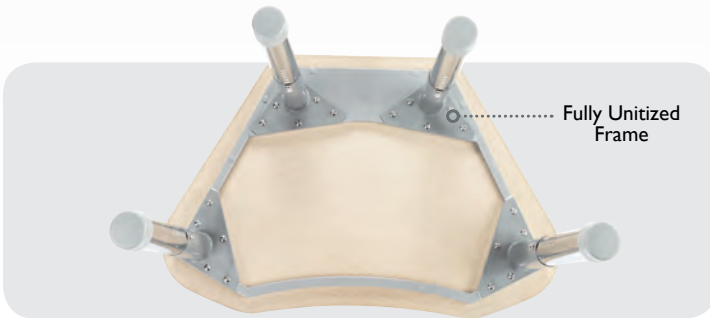

Fully Unitized Frame

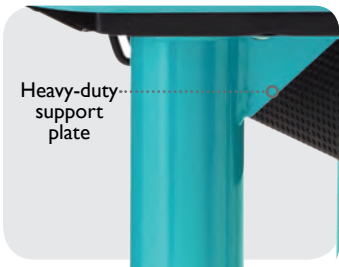

Heavy-duty support plate



Optional Bookbox

COMFORT

Collaborative learning paired with ample personal space.

BENEFITS

Nearly 500 square inches of desktop space—plenty of room for books and papers.

DESIGN

These versatile desks can be easily grouped together for collaborative learning.

STRENGTH

Our Hercules legs combined with our new unitized frame form Olympic strength to provide years of use.

Petal Series – School Desk

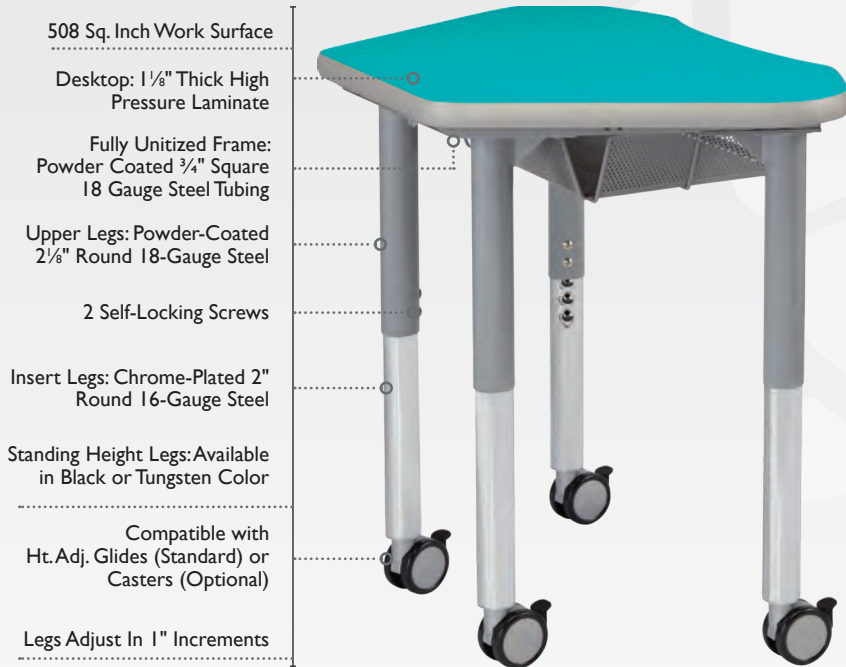

1900 - Petal Desk
(Shown with custom laminate Wilsonart Ocean #D502, optional Casters and Mesh Bookbox)

Standard (23-32\"H)	Toddler (17-22\"H)	Standing Ht. (26-42\"H)
Petal (32½ W × 20¼\" D)		
1900	1900S	1900SH
1900EE	1900EES	—
1900HP	1900HPS	1900HPSH
1900HPPEE	1900HPPEES	—

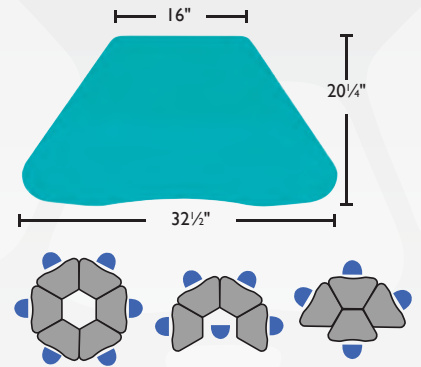

Standard (23-32\"H)	Toddler (17-22\"H)	Standing Ht. (26-42\"H)
Junior Petal (30¾ W × 21\" D)		
1950	1950S	1950SH
1950EE	1950EES	—
1950HP	1950HPS	1950HPSH
1950HPPEE	1950HPPEES	—

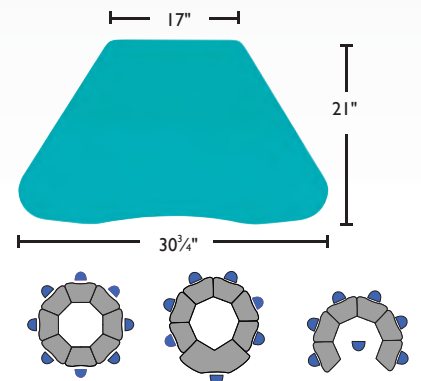

Optional Items: Backpack hook, Casters, Educational Edge (EE)*, Mesh Bookbox.

Standing Height Legs: Available in Black or Tungsten Color.

*Edge banding is only available on High Pressure Laminate Desktops. Edge banding & legs are black as a standard option unless Educational Edge is requested. Note the color needed when ordering.

Hard-Plastic Desktop Colors: Not Available in Light Gray and Beige.



1950EE - Junior Petal Desk
(Shown with optional Casters and Mesh Bookbox)

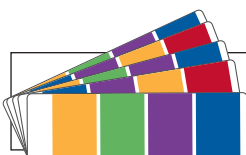

**Colors, Guides,
& Accessories**
See pages 112-117



See pages 114

STUDENT DESK



RUTHERFORD HIGH SCHOOL - RUTHERFORD, NJ



Innovation Series - Student Desk
Inspiration Series - Student Chair
Surge Series - School Desk

TRADITIONALLY MODERN

Surge Series – School Desk



1626 - **Surge Desk**
(Shown with custom laminate Wilsonart Flamingo #D497, optional Casters, Cup Holder and Mesh Bookbox)



Optional Mesh Bookbox

Newly & Improved Pneumatic Lift Mechanism



VERSATILITY

State-of-the-art adaptability maximizes attentiveness by letting students sit or stand with the same desk!



DESIGN

Safety lever (no pinching!) gives wide range of sitting and standing options. Larger desktop suits teacher, too. Basket optional.



BENEFITS

Use with any chair. Wide choice of finishes and colors. Choose glides or casters.



STRENGTH

Fully welded steel frame strapping and strong, yet surprisingly sleek. Angled to insure absolute stability, even at full height.



Optional Backpack Hook



Caster and Glide Compatible

Surge Series – School Desk



1626 - Surge Desk
 (Shown with custom laminate Formica Cascara Teakwood #D497 and optional Casters)



1629 - Surge Desk
 (Shown with custom laminate Wilsonart Flamingo #D497 and optional Mesh Bookbox)

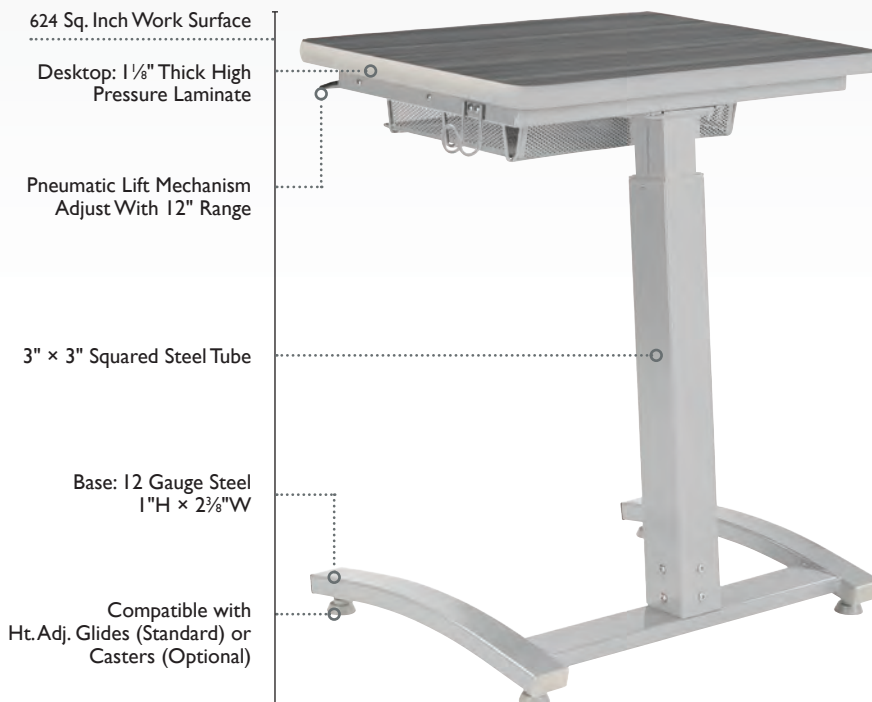

Model	Desk Height"	W x D"
High Pressure Laminate		
1626	26 1/2-38 1/2"	26 1/2 x 24"
1629	29-42"	26 1/2 x 24"
Hard-Plastic		
1626HP	26 1/2-38 1/2"	26 3/4 x 19 1/2"
1629HP	29-42"	26 3/4 x 19 1/2"
WoodStone		
1626WS	26 1/2-38 1/2"	26 3/4 x 19 1/2"
1629WS	29-42"	26 3/4 x 19 1/2"

Optional Items: Backpack hook, Mesh Bookbox, Casters and Rubber glides.

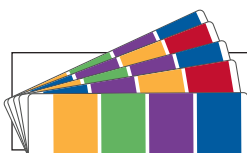

Colors, Guides, & Accessories
 See pages 112-117



See pages 114

TRADITIONALLY MODERN

Illustration V2 Series – School Desk



2729 - Fixed Height V2 Desk
(Shown with custom laminate Wilsonart Ocean #D502, optional Backpack Hook, Casters, Mesh Bookbox & Modesty Panel)



Underside with Crossbar



Optional Back Pack Hook



Adjustable Height



COMFORT

The wide frame design gives students extra leg room and the legs are height-adjustable for use in any grade.



DESIGN

The soft interlocking leg supports the dual legs on either side makes this desk the design of the future.



BENEFITS

The 500+ square inch desktop is designed to give the students plenty of room for their books and their laptop.



STRENGTH

The unitized frame design means that the desk is held together by steel tubing; not by the bookbox.

Illustration V2 Series – School Desk

520 Sq. Inch Work Surface
 Desktop: 5/8" Thick,
 26"W x 19 1/2"D

1" Steel Tube: 12-Gauge Steel,
 Welded At 90 Degree Angle

Stretcher Bar: 1 1/4" Diameter,
 18-Gauge Steel

Two 18 x 1/2" Machine Screws

Insert Legs: Two 1 1/8"
 Diameter 16-Gauge Steel
 Chrome Legs

Legs Adjust In 1" Increments



2700 - Adjustable Height V2 Desk
 (Shown with custom laminate Formica
 White Malachite #9949, optional Casters
 and Mesh Bookbox)

Model	Desk Height	W x D"
High Pressure Laminate		
2700	26-30"	27 3/4 x 19 1/2"
Hard-Plastic		
2700HP	26-30	26 3/4 x 19 1/2"
WoodStone		
2700WS	26-30	26 3/4 x 19 1/2"

Double Legs: Two 1 1/4"
 Diameter Tubes 16-Gauge Steel

Compatible with
 Ht. Adj. Glides (Standard) or
 Casters (Optional)



2729 - Fixed Height V2 Desk
 (Shown with custom laminate Wilsonart
 Ocean #D502, optional Backpack Hook,
 Casters, Mesh Bookbox & Modesty Panel)

Model	Desk Height"	W x D"
High Pressure Laminate		
2726	26"	27 3/4 x 19 1/2"
2729	29	27 3/4 x 19 1/2"
Hard-Plastic		
2726HP	26"	26 3/4 x 19 1/2"
2729HP	29	26 3/4 x 19 1/2"
WoodStone		
2726WS	26"	26 3/4 x 19 1/2"
2729WS	29	26 3/4 x 19 1/2"

Optional Items: Backpack Hook,
 Bookbox, Casters, Modesty Panel and
 Rubber glides.

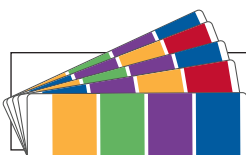

**Colors, Guides,
 & Accessories**
 See pages 112-117



See pages 114

TRADITIONALLY MODERN

T-Leg Series – School Desk



Matching Options



T-Leg Tables
See page 80-81

1500 - T-Leg Desk

(Shown with custom laminate Formica Ashen Ribbonwood #8839 and optional Mesh Bookbox)



Adjustable Height

Micro-Adjustable Glide

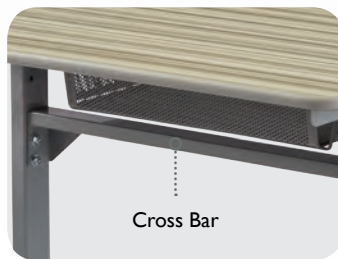

Cross Bar



Bookbox Pencil Groove

COMFORT

The wide frame design gives students extra leg room and the legs are height-adjustable for use in any grade.

DESIGN

Features a sturdy T-leg design which is secured by two self-locking screws and adjustable to heights from 22" to 32".

BENEFITS

The 500+ square inch desktop is designed to give the students plenty of room for their books and their laptop.

STRENGTH

The understructure is a unitized frame which makes this desk very sturdy.

T-Leg Series – School Desk



1500 - T-Leg Desk
(Shown with custom laminate Formica Ashen Ribbonwood #8839 and optional Mesh Bookbox)



1500 - T-Leg Desk
(Shown with custom laminate Formica Ashen Ribbonwood #8839)

- 520 Sq. Inch Work Surface
- Desktop: Fiberboard
5/8" Thick, 26" W x 19 1/2" D
- Stretcher Bar: 16-Gauge
Powder-Coated Rectangular
Tube, 1 1/8" W x 2 1/8" D
- Heavy Duty Bolts
- 15-Gauge Angle Iron
- Upper Legs: 16-Gauge Powder-
Coated Rectangular Tubing
1 1/8" W x 2 1/8" D
- Three Self-Locking Screws
- Insert Legs: 16-Gauge Chrome-
Plated Rectangular Tubing
1" W x 2" D
- Glides: Screw-In Style With
Nylon Base. Micro-Adjustable



Model	Desk Height"	W x D"
High Pressure Laminate		
1500	22 1/2-32 1/2"	27 3/4 x 19 1/2"
Hard-Plastic		
1500HP	22 1/2-32 1/2"	26 3/4 x 19 1/2"
WoodStone		
1500WS	22 1/2-32 1/2"	26 3/4 x 19 1/2"

Bookbox (WBB): Chrome-plated steel bookbox for T-leg Desks
18" W x 16" D x 5" H
To request, add "WBB" to the model when ordering. **Example:** 1500HPWBB

Optional Items: Rubber Glides, Casters, Mesh Bookbox.

T-Leg Desks are available with a Light Gray or Black Frame finish.

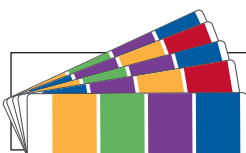

Colors, Guides,
& Accessories
See pages 112-117



See pages 114

TRADITIONALLY MODERN

Standard Series – School Desk with Plastic Bookbox



I100JEE2 - Adjustable Height Standard Desk with U-Brace

(Shown with custom laminate Formica Ashen Ribbonwood #8839)

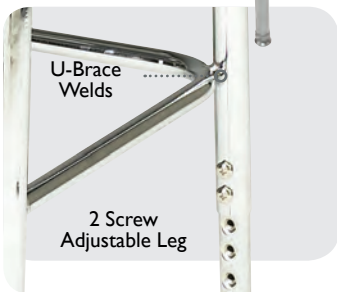

COMFORT

With its adjustable height and choice of desktops, this desk is sure to enable every student to work comfortably.

DESIGN

This tried-and-true design now features two self-locking screws on each adjustable leg.

BENEFITS

A plastic bookbox is as strong and long-lasting as steel yet it is quieter, lighter, rust proof and doesn't have sharp edges.

STRENGTH

The unitized frame design means that this desk is held together by steel tubing and braces; not by the bookbox. Make this desk even stronger with an optional U-brace.

Standard Series – School Desk with Plastic Bookbox

430 Sq. Inch Work Surface

Bookbox:
Heavy-Duty Propylene
21"W x 17"D x 4½"H

Upper Legs Chrome-Plated
1½" Round 18-Gauge Steel

Insert Legs: 1" 18-Gauge With
Two Self-Locking Screws

Glides: One Height Adjustable,
all four are self-leveling with
Nickel Plated Casing Nylon
Inserts.

Legs Adjust In 1" Increments



1100UEE2 - Adjustable Height Standard Desk with U-Brace
(Shown with custom laminate Formica Ashen Ribbonwood #8839)

Model	Adj. Desk Height"	W x D"
High Pressure Laminate		
1100	24-31"	24 x 18½"
1100EE	24-31	24 x 18½
1100EE2	24-31	24 x 18½
1100U	24-31	24 x 18½
1100UEE	24-31	24 x 18½
1100UEE2	24-31	24 x 18½
Hard-Plastic		
1100HP	24-31"	24 x 18½
1100HPPEE2	24-31	24 x 18½
1100UHP	24-31	24 x 18½
1100UHPEE2	24-31	24 x 18½
WoodStone		
1100WS	24-31"	24 x 18½
1100WSEE2	24-31	24 x 18½
1100UWS	24-31	24 x 18½
1100UWSEE2	24-31	24 x 18½

Legs: Chrome-Plated 1½"
Round 18-Gauge Steel



1150EE2 - Fixed Height Standard Desk
(Shown with custom laminate Formica Ashen Ribbonwood #8839)

Model	Fix. Desk Height"	W x D"
High Pressure Laminate		
1150	29½"	24 x 18½"
1150EE	29½	24 x 18½
1150EE2	29½	24 x 18½
1150U	29½	24 x 18½
1150UEE	29½	24 x 18½
1150UEE2	29½	24 x 18½
Hard-Plastic		
1150HP	29½"	24 x 18½"
1150HPPEE2	29½	24 x 18½
1150UHP	29½	24 x 18½
1150UHPEE2	29½	24 x 18½
WoodStone		
1150WS	29½"	24 x 18½"
1150WSEE2	29½	24 x 18½
1150UWS	29½	24 x 18½
1150UWSEE2	29½	24 x 18½

Optional Items: Glide Caps (Felt, Rubber and Steel), Educational Edge (EE)*, Colored Bookbox (EE2)**.

*Educational Edge (EE): Edge Banding only available on High Pressure Laminate desktops.

**Color Bookbox will match Educational Edge.

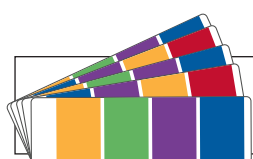

**Colors, Guides,
& Accessories**
See pages 112-117



See pages 114

TRADITIONALLY MODERN

Standard Series – School Desk with Metal Bookbox



1250 - Fixed Height Standard Desk
(Shown with custom laminates
Wilsonart Ocean #D502)



COMFORT

With its adjustable height and choice of desktops, this desk is sure to enable every student to work comfortably.

DESIGN

This tried-and-true design now features two self-locking screws on each adjustable leg.

BENEFITS

The steel bookbox with built-in pencil tray has ample room for a student's books.

STRENGTH

The unitized frame design means that this desk is held together by steel tubing and braces; not by the bookbox. Make this desk even stronger with an optional U-brace.

Standard Series – School Desk with Metal Bookbox

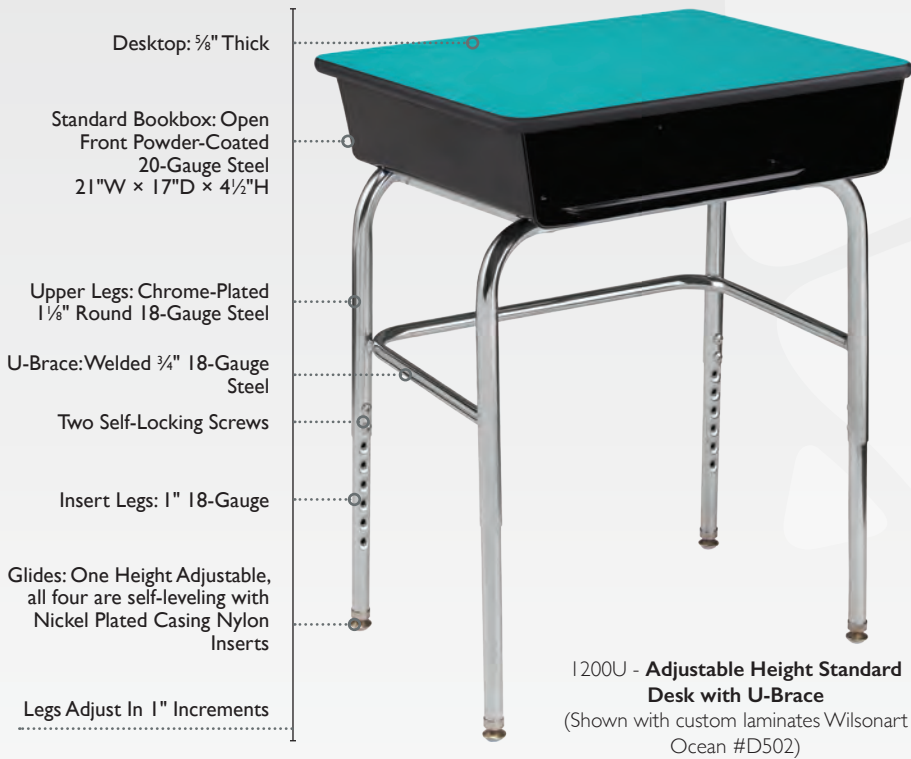

Model	Adj. Desk Height"	W x D"
High Pressure Laminate		
1200	24-31"	24 x 18 1/2"
1200EE	24-31	24 x 18 1/2"
1200U	24-31	24 x 18 1/2"
1200UEE	24-31	24 x 18 1/2"
Hard-Plastic		
1200HP	24-31"	24 x 18 1/2"
1200UHP	24-31	24 x 18 1/2"
WoodStone		
1200WS	24-31"	24 x 18 1/2"
1200UWS	24-31	24 x 18 1/2"



Model	Fix. Desk Height"	W x D"
High Pressure Laminate		
1250	29 1/2"	24 x 18 1/2"
1250EE	29 1/2"	24 x 18 1/2"
1250U	29 1/2"	24 x 18 1/2"
1250UEE	29 1/2"	24 x 18 1/2"
Hard-Plastic		
1250HP	29 1/2"	24 x 18 1/2"
1250UHP	29 1/2"	24 x 18 1/2"
WoodStone		
1250WS	29 1/2"	24 x 18 1/2"
1250UWS	29 1/2"	24 x 18 1/2"

Optional Items: Glide Caps (Felt, Rubber and Steel), Educational Edge (EE)*.

*Educational Edge (EE): Edge Banding only available on High Pressure Laminate desktops. Note the color needed at the time of ordering.

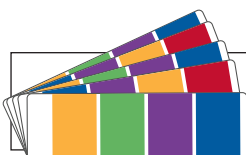

Colors, Guides, & Accessories
See pages 112-117



See pages 114

TRADITIONALLY MODERN

Standard Series – Open View/Writing/Wheelchair School Desk



1400U - Adjustable Writing Desk with U-Brace
(Shown with custom laminate Formica
Matrix Blue #8795)

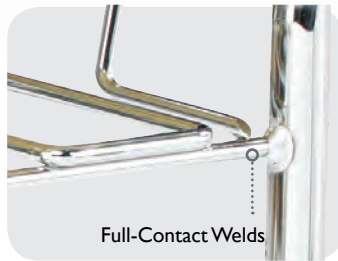

COMFORT

With its adjustable height and choice of desktops, these desks are sure to enable every student to work comfortably.

DESIGN

This tried-and-true design now features two self-locking screws on each adjustable leg.

BENEFITS

The open-view storage area ensures that only necessary supplies are inside; no rotten apples or hidden contraband inside this desk.

STRENGTH

The unitized frame design means that this desk is held together by steel tubing and braces; not by the bookbox. Make this desk even stronger with an optional U-brace.

Standard Series – Open View/Writing/Wheelchair School Desk

430 Sq. Inch Work Surface

Bookbasket: 8-Gauge Steel
19"W × 14"D × 5"H

Upper Legs: Chrome-Plated
1½" Round 18-Gauge Steel

Ubrace: ¾" 18-Gauge Steel
Welded To All Four Legs For
Extra Support

Two Self-Locking Screws
Insert Legs: 1" 18-Gauge

Glides: One Height Adjustable,
all four are self-leveling with
Nickel Plated Casing Nylon
Inserts

Legs Adjust In 1" Increments

1300U - **Open View Standard Desk
with U-Brace**
(Shown with custom laminate Formica
Matrix Blue #8795)

Adjustable (24-31" H)	Fixed (29½" H)	W × D"
High Pressure Laminate w/ bookbasket		
1300	1350	24 × 18½"
1300U	1350U	24 × 18½"
Hard-Plastic w/ bookbasket		
1300HP	1350HP	24 × 18½"
1300UHP	1350UHP	24 × 18½"
WoodStone w/ bookbasket		
1300WS	1350WS	24 × 18½"
1300UWS	1350UWS	24 × 18½"

Adjustable (24-31" H)	Fixed (29½" H)	W × D"
High Pressure Laminate w/o bookbasket		
1400U	1450U	24 × 18½"
Hard-Plastic w/o bookbasket		
1400UHP	1450UHP	24 × 18½"
WoodStone w/o bookbasket		
1400UWS	1450UWS	24 × 18½"

520 Sq. Inch Work Surface

Wider Frame And A Higher
Top To Accommodate A
Wheelchair

U-Brace: Standard For Added
Stability

1800UHP - **ADA Standard Desk with
U-Brace**
(Shown with custom laminate Formica
Matrix Blue #8795)

Model	Adj. Desk Height"	W × D"
High Pressure Laminate		
1800U	26-34"	36 × 20"
Hard-Plastic		
1800UHP	26-34"	36 × 20"



Optional Items: Glide Caps (Felt, Rubber and Steel).

Woodstones Desktops only available on the 1300 & 1400 series.

ADA 1800UHP - Only available in Beige, Gray Nebula, Light Gray and Wild Cherry.

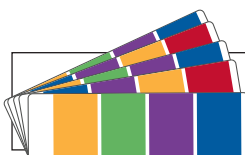

**Colors, Guides,
& Accessories**
See pages 112-117



See pages 114

Double Desks



2759 - Fixed Height Illustration V2
Double Desk
(Shown with custom laminate Formica
Silver Oak Herringbone #9311)

Matching Options



Illustration V2
Desk
See page 34-35



Thick Desktop

Spacious Bookboxes



Full-Contact
Welds

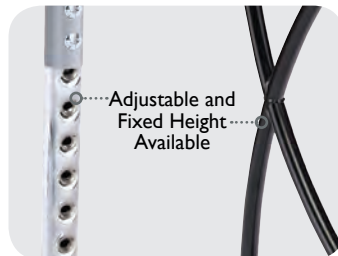

Adjustable and
Fixed Height
Available



VERSATILITY

Adjustable-height legs for student comfort, bookboxes can face either direction for any classroom layout.



BOOKBOXES

Sturdy 18-gauge bookboxes are roomy enough to hold everything a student needs, and strong enough to keep it secure. Rolled edges protect student and add strength.



BENEFITS

Get twice the learning. Students can work together or independently.



STRENGTH

The unitized frame is self-supporting, meaning that the table is held together by heavy-gauge steel, not by the top.

Double Desks

- Desktop: 1/8" Thick High-Pressure Laminate With Edge-Banding
- Stretcher Bar: 16-Gauge Powder-Coated Rectangular Tube Welded 1/8"W x 2 1/8"D
- Support: 15-Gauge Angle Iron
- Upper Leg: 16-Gauge Powder-Coated Rectangular Tubing 1 1/8"W x 2 1/8"D
- Three Self-Locking Screws
- Insert Leg: 16-Gauge Chrome-Plated Rectangular Tubing 1"W x 2"D
- Glides: Self-Adjusting Nickel-Plated Casing With Nylon Inserts



1550 - T-Leg Double Desk
(Shown with custom laminate Formica Silver Oak Herringbone #9311)

Model	Table Height"	W x D"
T-Leg Series Double Desk		
1550	22 1/2-32 1/2"	48 x 24"

Matching Options



T-Leg Desk
See page 36-37

Optional Items: Backpack Hook, Glide Caps, Casters.

T-Leg Double Desk are not available with a Light Gray or Black Frame Finish.

Model	Table Height"	W x D"
Activity Series Double Desk		
1650	23-32"	48 x 24"

Optional Items: Backpack Hook, Glide Caps.

- Upper Leg: 1 1/8" Outer-Diameter Powder-Coated Tubular Steel
- Self-Locking Screws
- Insert Leg: 1" Outer-Diameter 16-Gauge Chrome-Plated Tubular Steel
- Glides: Self-Adjusting Nickel-Plated Casing With Nylon Inserts
- Legs Adjust In 1" Increments



1650 - Activity-Leg Double Desk
(Shown with custom laminate Formica Silver Oak Herringbone #9311)

Model	Table Height"	W x D"
Illustration V2 Series Double Desk		
2750	27 1/2-31 1/2"	48 x 24"
2759	29	48 x 24"

- 1" Steel Tube: 12-Gauge Steel, Welded At 90 Degree Angle
- Stretcher Bar: 1 1/4" Diameter, 18-Gauge
- Frame: Two 1 1/4" Diameter Tubes 16-Gauge Steel
- Compatible with Ht. Adj. Glides (Standard) or Casters (Optional)



2759 - Fixed Height Illustration V2 Double Desk
(Shown with custom laminate Formica Silver Oak Herringbone #9311)



2750
Two 1 1/2" Diameter, 16-Gauge Steel Chrome Legs
Height Adjustable 27 1/2-31 1/2"

Optional Items: Backpack Hook, Glides, Casters.

Bookboxes are standard on all Double Desk. See all standard bookboxes on page 117.

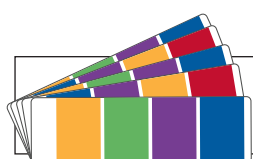

Colors, Guides, & Accessories
See pages 112-117

COMBO DESK



GARNER FINE ARTS ACADEMY - GRAND PRAIRIE, TX



Unity Study – School Combo Desk

COMBO DESK

Unity Study – School Combo Desk



2958C - 18" Unity Study Combo Desk
(Shown with custom laminate Formica
Weathered Beamwood #6410)

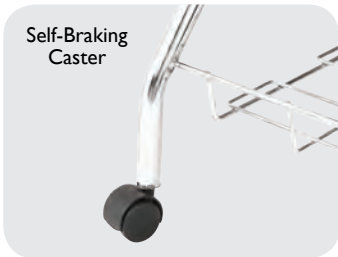

DESIGN

Curvy and comfy, this student combo features locking casters, roomy and accessible book storage under seat, and a unique design for collaborative work study.



VERSATILITY

Move it where you need it, easily arrange 2 or more students to work together. Simply slide back to solo work when group project is done.



BENEFITS

Sitting on the chair locks casters into place securely. Efficiently re-group students as needed with one-handed ease.



STRENGTH

Long-lasting, will never tip or slide once secured. Desk surface is hard plastic or laminate meant to stand up to years of wear.

Unity Study – School Combo Desk

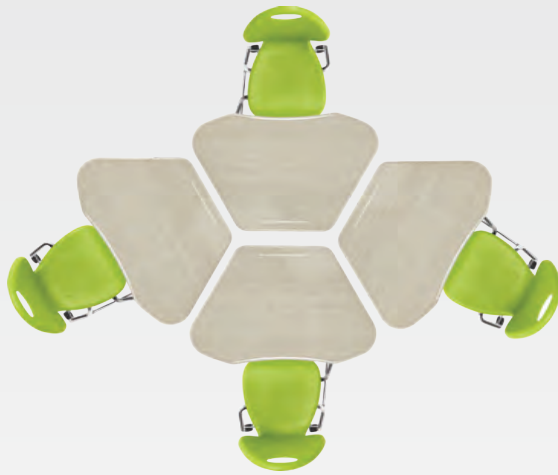

Pod of Four

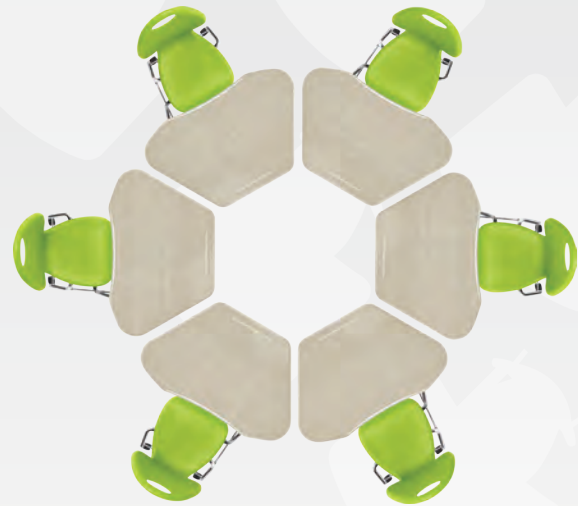

Pod of Six

- 507 Sq. Inch Work Surface
- Built-In Carry Handle
- Shell: One-Piece, Color-Impregnated Polypropylene Molded Plastic
- Desktop: 5/8" Thick
- Lumbar Support
- Seat and Desktop Supports: 1 1/8" Round 14-Gauge Steel
- Bookbasket: Chrome-Plated 1/4" Rod Steel 14 1/2"W x 12"D x 8"H
- Back Legs: Chrome-Plated, 1 1/8"- Round 18-Gauge Steel
- Double Hooded 2" Self-Braking Casters
- Front Legs: Chrome-Plated 1 1/8" Round 16-Gauge Steel
- Self-Adjusting Nylon Glides



Model	Seat Height"	W x H x D"
High Pressure Laminate		
2958	18"	32 1/2 x 29 x 38 1/2"
2958C	18	32 1/2 x 29 x 38 1/2"
Hard Plastic		
2958HP	18"	32 1/2 x 29 x 38 1/2"
2958CHP	18	32 1/2 x 29 x 38 1/2"

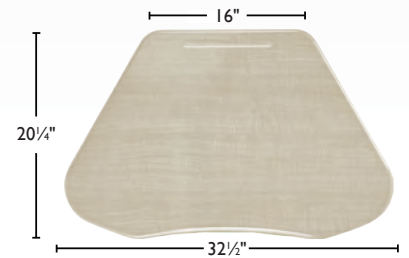

Optional Items: Glide Caps (Felt, Rubber and Steel), and Hard & Soft Casters.

Dimensions of overall combo provided. For seat dimensions, please see the grid on Page 9.

Back Casters can be replaced with glides.

Bookbasket on combo is standard, but can be requested without one at the time of ordering. Bookbasket must be installed by manufacturer.

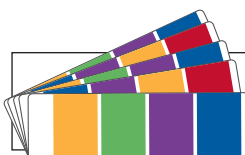

Colors, Guides, & Accessories
See pages 112-117



See pages 114

COMBO DESK

Inspiration Series – School Combo Desk



Curved Desktop and Support Brace



Full-Contact Welds



X-Plus Offers Additional 1" Clearance from Seat to Desktop



DESIGN

Inspirational shell design, arc-shaped WoodStone desktop, and curved U-brace.



COMFORT

The dual curves and flex action of the back provide exceptional back support.



STRENGTH

Heavy-gauge, 1 1/8" round tubing with standard U-brace, full contact welds.



BENEFITS

120 Memory swivel seat allows for easy entry and exit.

Inspiration Series – School Combo Desk



Model	Seat Height"	W x H x D"
WoodStone		
2914WS	14"	27 x 24 3/4 x 34"
2916WS	16	27 x 31 1/2 x 37
2918WS	18	27 x 33 1/2 x 37
2918XWS	18	27 x 33 1/2 x 37
2919WS	19	27 x 34 1/2 x 37
2919XWS	19	27 x 34 1/2 x 37



Model	W x H x D"
Sled Base (Seat Height 18")	
2918WSSB	27 x 33 1/2 x 38"

X-Plus (X): Larger shell and Frame for added weight capacity available.

Optional Items: Glide Caps (Felt, Rubber and Steel) and Rubber & Nylon screw-in glides for Sled Base combo.

Dimensions of overall combo provided. For seat dimensions, please see the grid on Page 9

Bookbasket on combo is standard, but can be requested without one at the time of ordering. Bookbasket must be installed by manufacturer.

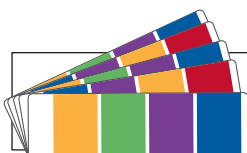

Colors, Guides, & Accessories See pages 112-117



See pages 114

COMBO DESK

Classic Series – School Combo Desk



2218 -18" Classic Combo Desk
(Shown with custom laminate
Formica Clementine #2962)



14-Gauge
Underseat Steel



Bookbasket



Steel Back
Supports

COMFORT

Classic waterfall edge seat with curved, vented back and unobstructed legroom add up to classic comfort.

DESIGN

In any classroom old or new, our curved seat and vented back offer a timeless design. 400+ square inch desktop.

BENEFITS

The one-piece design combo desk, with built-in bookbasket and pencil groove will keep your students happy and the classroom neat.

STRENGTH

Side-by-side tubular steel back supports, seatback ribs and 14-gauge underseat brackets combine with an angled side-brace for added stability.

Classic Series – School Combo Desk



Model	Seat Height"	W x H x D"
High Pressure Laminate		
2214	14"	24 x 27 3/4 x 34"
2216	16	24 x 29 1/2 x 33
2218	18	24 x 31 1/2 x 33
2219	19	24 x 33 x 36
Hard-Plastic		
2214HP	14"	24 x 27 3/4 x 34"
2216HP	16	24 x 29 1/2 x 33
2218HP	18	24 x 31 1/2 x 33
2219HP	19	24 x 33 x 36
WoodStone		
2214WS	14"	24 x 27 3/4 x 34"
2216WS	16	24 x 29 1/2 x 33
2218WS	18	24 x 31 1/2 x 33
2219WS	19	24 x 33 x 36

Note: All models also available in left-handed versions. Specify Left Hand (LH) at the time of ordering.



Model	W x H x D"
Sled Base (Seat Height 18")	
2618	27 x 33 1/4 x 38"
2618HP	27 x 33 1/4 x 38
2618WS	27 x 33 1/4 x 38

Optional Items: Glide Caps (Felt, Rubber and Steel) and Rubber & Nylon screw-in glides for Sled Base combo.

Dimensions of overall combo provided. For seat dimensions, please see the grid on Page 11

Bookbasket on combo is standard, but can be requested without one at the time of ordering. Bookbasket must be installed by manufacturer.

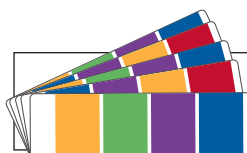

Colors, Guides, & Accessories See pages 112-117



See pages 114

COMBO DESK

Hard-Plastic Series – School Combo Desk



2518 - 18" Hard-Plastic
Combo Desk
(Shown with custom laminate
Wilsonart Ocean #D502)



Optional Sled Base Glide



Under Desktop Construction



Full-Contact
Welds

Bookbasket

COMFORT

The contoured seat and posture-perfect back are mated to a choice of desktops to create a comfortable work center.

DESIGN

This time-tested design encourages teacher-student learning while keeping the classroom neat and tidy.

STRENGTH

Our strongest seat and back plus our strongest frame makes this one of the strongest combos available.

BENEFITS

The one-piece construction of this combo brings together our hard-plastic chair and desktop, in one easy-to-move unit.

Hard-Plastic Series – School Combo Desk



2518 - 18" Hard-Plastic Combo Desk

Model	Seat Height"	W × H × D"
High Pressure Laminate		
2514	14"	24 × 27½ × 33"
2516	16	24 × 29½ × 34
2518	18	24 × 31¼ × 34
2519	19	24 × 32¾ × 36
Hard Plastic		
2514HP	14"	24 × 27½ × 33"
2516HP	16	24 × 29½ × 34
2518HP	18	24 × 31¼ × 34
2519HP	19	24 × 32¾ × 36
WoodStone		
2514WS	14"	24 × 27½ × 33"
2516WS	16	24 × 29½ × 34
2518WS	18	24 × 31¼ × 34
2519WS	19	24 × 32¾ × 36

Note: All models also available in left-handed versions.



2628 - 18" Sled Base Combo Desk

Model	W × H × D"
Sled Base (Seat Height 18")	
2628	24 × 32 × 35"
2628HP	24 × 32 × 35
2628WS	24 × 32 × 35

Optional Items: Glide Caps (Felt, Rubber and Steel) and Rubber & Nylon screw-in glides for Sled Base combo

Dimensions of overall combo provided. For seat dimensions, please see the grid on Page 13

Bookbasket on combo is standard, but can be requested without one at the time of ordering. Book basket must be installed by manufacturer.

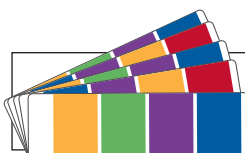

Colors, Guides, & Accessories
See pages 112-117



See pages 114

COMBO DESK

Hard-Plastic Series – Braced School Combo Desk



2538WS - Double Braced Combo Desk with Arc-Shaped WoodStone Desktop



Pencil Groove

Jumbo Tablet-Arm Work Surface



Bookbasket



Full-Contact Welds

STRENGTH

Our hard-plastic seat and back are paired with a braced frame design to make the strongest combo desk available.

DESIGN

This time-tested design encourages teacher-student learning while keeping the classroom neat and tidy.

BENEFITS

The combo design and integrated bookbasket keep both the students and their books in the right place.

COMFORT

The contoured seat and posture-perfect back are paired with a spacious rectangular desktop or tablet-arm.

Hard-Plastic Series – Braced School Combo Desk

- Back: 5/8" Thick Hard-Plastic
13 1/2" W x 6 3/8" L
- Desktop: 5/8" Thick Hard-Plastic With Pencil Groove
- Back Support: 3/4" Round
16", 18" & 19" - 14-Gauge Steel
14" Combos - 16-Gauge Steel
- Seat: 5/8" Thick
- Seat and Desktop Supports:
Chrome-Plated 1 1/8" Round,
14-Gauge Steel
- Bookbasket: Chrome-Plated
1/4" Rod Steel
14 1/2" W x 12" D x 8" H
- Back Legs: Chrome-Plated
1 1/8" Round, 18-Gauge Steel
- Front Legs: Chrome-Plated
1 1/8" Round, 16-Gauge Steel
- Self-Adjusting Nylon Glides



2528HP - Single Braced Combo Desk with Rectangular Hard-Plastic Desktop

Model	Seat Height"	W x H x D"
-------	--------------	------------

High-Pressure Laminate		
2524	14"	24 x 27 1/2 x 33"
2526	16	24 x 29 1/2 x 34
2528	18	24 x 31 1/4 x 34
2529	19	24 x 32 3/4 x 34

Hard-Plastic		
2524HP	14"	24 x 27 1/2 x 33"
2526HP	16	24 x 29 1/2 x 34
2528HP	18	24 x 31 1/4 x 34
2529HP	19	24 x 32 3/4 x 36

WoodStone		
2524WS	14"	24 x 27 1/2 x 33"
2526WS	16	24 x 29 1/2 x 34
2528WS	18	24 x 31 1/4 x 34
2529WS	19	24 x 32 3/4 x 36

Regular desks also available in left-handed versions.

Jumbo Tablet-Arm Work Surface



2528JHP - Single Braced Combo Desk with Tablet-Arm Jumbo Hard-Plastic Desktop

Model	Seat Height"	W x H x D"
-------	--------------	------------

Hard-Plastic Tablet-Arm		
2524JHP	14"	24 x 27 1/2 x 33"
2526JHP	16	24 x 29 1/2 x 34
2528JHP	18	24 x 31 1/4 x 34
2529JHP	19	24 x 32 3/4 x 36

WoodStone Tablet-Arm		
2524JWS	14"	24 x 27 1/2 x 33"
2526JWS	16	24 x 29 1/2 x 34
2528JWS	18	24 x 31 1/4 x 34
2529JWS	19	24 x 32 3/4 x 36

Tablet-arms available in right-handed versions only.

Double Braced Frame: Includes 8 gauge wrap around tubing for added strength and support. All combos available in double braced version. To request, use root model number 253. **Example:** 2538HP

Optional Items: Glide Caps (Felt, Rubber and Steel).

Dimensions of overall combo provided. For seat dimensions, please see the grid on Page 13

Bookbasket on combo is standard, but can be requested without one at the time of ordering. Bookbasket must be installed by manufacturer.

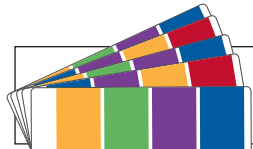

Colors, Guides, & Accessories
See pages 112-117



See pages 114

COMBO DESK

Classic and Hard Plastic Series – School Tablet-Arm Combo



3218HP - 18" Classic
Tablet-Arm Combo Desk



3518HP - 18" Right Handed Hard
Plastic Tablet-Arm Combo Desk



Dual-Arm
Desktop
Support



Bookbasket



Underseat
Steel
Structure



COMFORT

The contoured seat and posture-perfect back are mated to a choice of desktops to create a comfortable work center.



BENEFITS

The angled inside edge of the desktop along with the tablet-arm area offers easy access and are super supportive.



DESIGN

Designed for testing and lighter-use areas. Perfect for quick turnover applications.



STRENGTH

Made with 18-gauge steel legs and 14-gauge steel braces, these tablet-arm chairs are built to last.

Classic and Hard Plastic Series – School Tablet-Arm Combo



3218HP - 18" Classic Tablet-Arm Combo

Model	Seat Height"	W x H x D"
WoodStone		
3216WS	16"	21 x 29 x 31"
3218WS	18"	21 x 31½ x 31"
3219WS	19"	21 x 31½ x 32"
Hard-Plastic		
3216HP	16"	21 x 29 x 31"
3218HP	18"	21 x 31½ x 32"
3219HP	19"	21 x 31½ x 32"

Classic Tablet-Arm Combo available in right-handed version only.

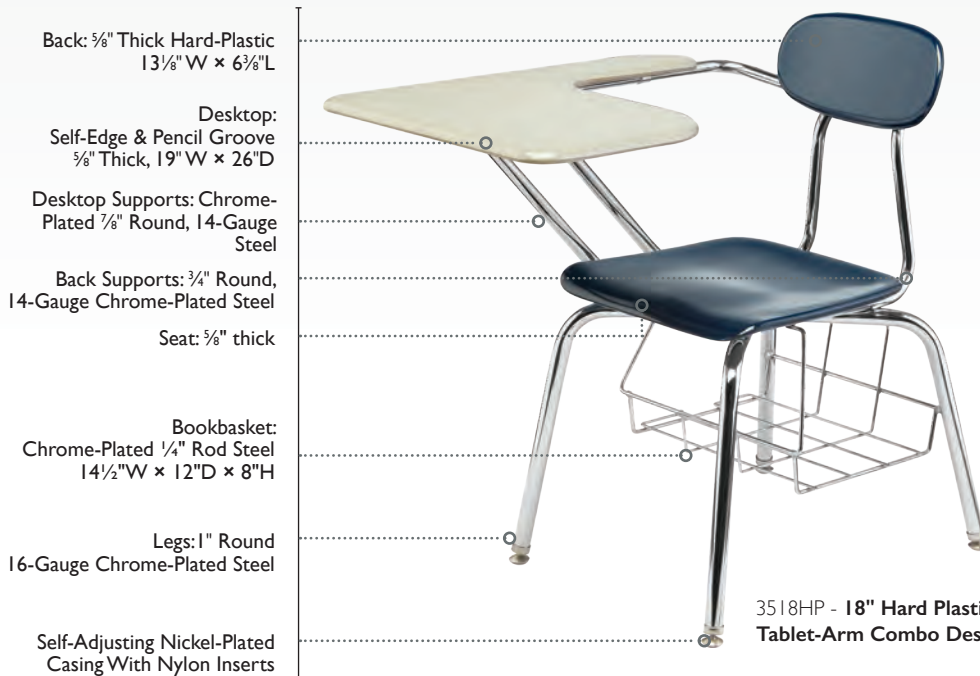
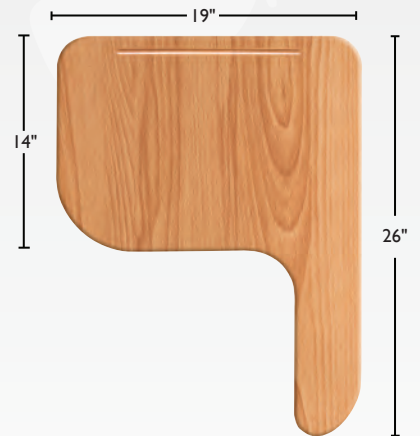

3518HP - 18" Hard Plastic Tablet-Arm Combo Desk

Model	Seat Height"	W x H x D"
WoodStone		
3516WS	15¾"	20 x 28½ x 31"
3518WS	17¾"	20 x 30½ x 31"
3519WS	19"	20 x 31½ x 31"
Hard-Plastic		
3516HP	15¾"	20 x 28½ x 31"
3518HP	17¾"	20 x 30½ x 31"
3519HP	19"	20 x 31½ x 31"

Hard Plastic Tablet-Arm Combo available in right-handed version only.

Optional Items: Glide Caps (Felt, Rubber and Steel).

Dimensions of overall combo provided. For seat dimensions, please see the grid on Page 11 & 13

Bookbasket on combo is standard, but can be requested without one at the time of ordering. Bookbasket must be installed by manufacturer.

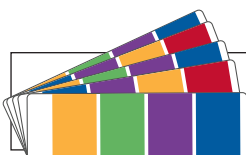

Colors, Guides, & Accessories
See pages 112-117



See pages 114

Nate Series – Teacher Station

PATENTED



Demo Video Available
Search: Academia Furniture Nate



TSPM-2468 - Nate Teacher Station
with Mobile Podium
(Shown with a custom laminate Formica Myriad
Ribbonwood #863)



DESIGN

Stunningly sleek, this magnificent teacher's desk has raised the bar of beauty, innovation and adaptability in the industry.



BENEFITS

Roomy, locking storage and file drawers. Special casters allow return to swing in or out with ease. Modesty panel for teacher comfort.



VERSATILITY

With a unique built-in podium, a simple pull of a lever can raise, lower or tilt lectern as needed. Retractable return allows for almost twice the desktop space, disappears when not needed.



STRENGTH

Enhancements include threaded inserts in table top, preset with steel into wood table top for years of long-lasting and unshakable wear.

Nate Series – Teacher Station



TSPM-2468 - Nate Teacher Station with Mobile Podium
(Shown with a custom laminate Formica Myriad Ribbonwood #863)

- Adjustable Podium Top Ranging From 29-42" High
- Angled Podium Surface Adjusting To 45 Degrees
- Locking Drawers: 2 Drawers & 1 Ball Bearing File Drawer
- Powder Coated Steel Box



TSPM-1824 - Podium

Model	Desk Height"	W x D"
Teacher Station w/ Stationary Podium		
TSP-2468	29"	68 x 24"
Teacher Station w/ Mobile Podium		
TSPM-2468	29"	68 x 24"
Podium		
TSPM-1824	29"	18½ x 24"

Must note if retractable return is wanted on right or left side of the teacher station at the time of ordering. Add LH/RH to the model number.

- 2230 Sq. Inch Work Surface
- Tabletop: 1½" Fiberboard With High Pressure Laminate Surface & Black PVC Edge Banding*
- Modesty Panel: Powder Coated 18 Gauge Steel
- 3 Legs: 2¾" Diameter, Powder Coated, 16 Gauge Steel Legs, Screwed Into Heavy Duty Table Inserts
- Inverted Caster for the Inner Pivot Leg & Rubber Lined Glide for the Stationary Leg
- Heavy Duty Locking Caster



TSPM-2468 - Teacher Station with Mobile Podium
(Shown with a custom laminate Formica Myriad Ribbonwood #863)

Optional Items: Power Supply 2 AC power, Power Supply 1 AC with 2 USB outlets.

* PVC Edge Banding is available in Black (Standard) and Gray (Optional).

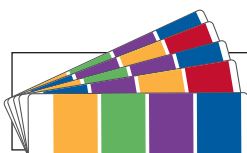

Colors, Guides, & Accessories
See pages 112-117

TEACHER DESK

Nate Series – Teacher Desk



TS-3060 - Double Pedestal Desk



DESIGN

Stunningly sleek, this magnificent teacher's desk has raised the bar of beauty, innovation and adaptability in the industry.



BENEFITS

Roomy, locking storage and file drawers. Special casters allow return to swing in or out with ease. Modesty panel for teacher comfort.



VERSATILITY

With unique built-in inverted casters, the Nate Jr can be moved around the classroom to adapt to the ever changing teaching styles. The standard 6" overhang is great for teacher-student conferences.



STRENGTH

Thick gauges of steel, heavy-duty hardware and durable construction will ensure this desk will last for years of use.

Nate Series – Teacher Desk

- 1420 Sq. Inch Work Surface
- Tabletop: 1 1/8" Fiberboard with High Pressure Laminate Surface & Black PVC Edge Banding*
- Power Coated Steel Pedestal
- Locking Drawers: 2 Drawers
1 Ball-Bearing File Drawer
- Modesty Panel: Powder Coated 18 Gauge Steel
- 2 Inverted Casters
- 2 Legs: 2 3/8" Diameter, Powder Coated, 16 Gauge Steel



TS-3048 - **Single Pedestal Desk**
(Shown with custom laminate Formica Smokey Brown Pear #5488)

Model	Desk Height"	W x D"
Single Pedestal		
TS-3048	29"	48 x 30"

- Peninsula Tabletop: 36" Diameter
Rectangular End 30" Deep
- 2 Legs: 2 3/8" Diameter, Powder Coated, 16 Gauge Steel
- Locking Drawers: 2 Drawers
1 Ball-Bearing File Drawer



TS-3672P - **Peninsula Desk**
(Shown with custom laminate Formica Smokey Brown Pear #5488)

Model	Desk Height"	W x D"
Peninsula		
TS-3672P	29"	72 x 36"

- 1788 Sq. Inch Work Surface
- Double Pedestal: 2 Powder Coated Steel Pedestals
- Locking Drawers: 4 Drawers
2 Ball-Bearing File Drawer



TS-3060 - **Double Pedestal Desk**

Model	Desk Height"	W x D"
Double Pedestal		
TS-3060	29"	60 x 30"

Optional Items : 2" locking casters (available on Double Pedestal desk), Keyboard Tray, Pencil Tray, Power Supply.

* PVC Edge Banding is available in Black (Standard) and Gray (Optional).

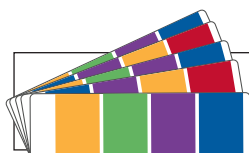

**Colors, Guides,
& Accessories**
See pages 112-117

TEACHER DESK

Petal Series – Lazer Teacher Desk



Demo Video Available
Search: Academia Furniture Lazer



TS-2868 - **Lazer Teacher Desk**
(Shown with custom laminate Formica
Weathered Beamwood #6410)

Matching Options



Jr. Petal Desk
See page 28-29



BENEFITS

Enhances collaborative study environments, completes pod of 6 student desks. Modesty panel and pencil drawer standard.



COMFORT

Arched front for enhanced teacher/student conversation. Teacher can comfortably work with multi-student clusters without strain.



DESIGN

Handsome hexagonal, winged design. Long-lasting laminate surface with edge banding complements students desks. Various furniture finish options.



VERSATILITY

Easy gliding casters makes reconfiguring a breeze. Effortlessly move among student groups. Cutting edge for cooperative education settings.

Petal Series – Lazer Teacher Desk

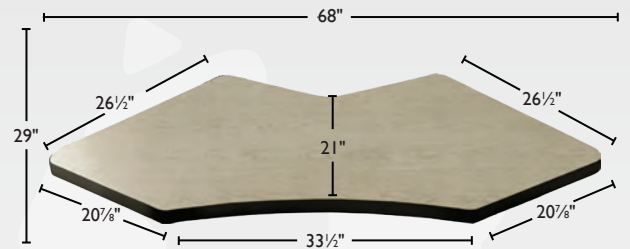

TS-2868 - **Lazer Teacher Desk**
 (Shown with 1950 Junior Petal Desk with optional casters, all in custom laminate Formica Weathered Beamwood #6410)

- 1305 Sq. Inch Work Surface

- Table Top: 1 1/8" Particleboard Core with a 1/32" High Pressure Laminated Surface, and .020" Poly Backer Sheet Covered Underside

- 3MM PVC Edge Banding*
Pencil Drawer

- Upper Legs: 2" Diameter, 18-Gauge Steel Powder Coated Finish

- Insert Legs: 1.875", 16 Gauge Steel, Chrome Plated Finish

- Modesty Panel: 18-Gauge Perforated Panel Extends 15"

- Braking Casters Are Standard



Model	Desk Height"	W x D"
Lazer Teacher Desk		
TS-2868	23-32"	68 x 29"

* PVC Edge Banding is available in Black (Standard) and Gray (Optional).

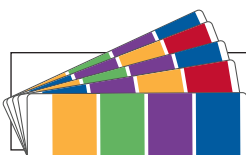

**Colors, Guides,
 & Accessories**
 See pages 112-117

TEACHER DESK

Vantage Series – Teacher Desk



TVSHF-2430 - Standing Fixed Height Vantage Desk
(Shown with optional Casters and Cup Holder)

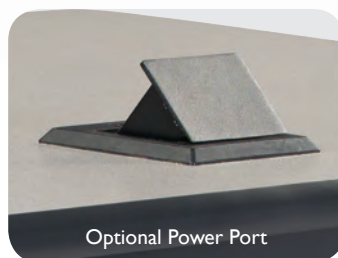

BENEFITS

Jump-start your collaborative classroom with this comfortable, convenient and easily mobile teacher's desk.



DESIGN

Neat and compact design lets you stand or sit wherever your students are. Great vantage point for overview of class. Pick your size and height.



VERSATILITY

Wood desktop in 6 standard colors, many custom colors; Steel frame in 2 colors. Casters or Glides. Height adjustable or fixed with footrest. Power source option.



COMFORT

Simple, solid, sensible. Go with the flow of the class. Features Modesty panel on all sizes and slide-out pencil drawer.

Vantage Series – Teacher Desk

- 700 Sq. Inch Work Surface
- Tabletop: 1 1/8" Particleboard
Core 1/2" High Pressure
Laminated Surface
.020" Poly Backer Sheet
Underside
- 3MM Pvc Edge Banding*
- Unitized Steel Frame 2" x 1"
18-Gauge Rectangular Tubes
- Foot Rest: 18-Gauge Steel
- Compatible with
Ht. Adj. Glides (Standard) or
Casters (Optional)



**TVF-2430 - Fixed Height
Vantage Teacher Desk**
(Shown with custom laminate Wilsonart Aqua
Fizz #4934, optional Casters & Pencil Drawer)

Model	Desk Height"	W x D"
Fixed Height		
TVF-2430	29"	30-24"
TVF-3048	29"	36-24"

- 1420 Sq. Inch Work Surface
- Steel Legs: 1 7/8" Diameter
16-Gauge
- Legs Adjust In
1" Increments
- Modesty Panel: 18-Gauge
Perforated Steel
- Compatible with
Ht. Adj. Glides (Standard) or
Casters (Optional)



**TVSHA-3048 - Adjustable
Standing Height Vantage
Teacher Desk**
(Shown with optional Power
Supply & Casters)

Model	Desk Height"	W x D"
Fixed Standing Height		
TVSHF-2430	42"	30-24"
TVSHF-3048	42"	36-24"
Adjustable Standing Height		
TVSHA-2430	33-42"	30-24"
TVSHA-3048	33-42"	36-24"

Optional Items: Casters, Pencil Drawer, Power Port.

* PVC Edge Banding is available in Black (Standard) and Gray (Optional).

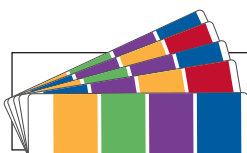

**Colors, Guides,
& Accessories**
See pages 112-117

CLASSROOM TABLE



MEADOWLARK ES - SALT LAKE CITY, UT



Zed Series – School Chair
Hercules Series – Round Table
Harmony Series – Chord Table

CLASSROOM TABLE

Hercules Series – Group-Study and Activity Table



HLEE-6060PL - Inspiration Table
(Shown with custom laminate Formica Charcoal Boomerang #6942 and Lime Green Inspiration Chairs)



STRENGTH

The Hercules legs are the strongest available to provide years of sturdy usage and are paired with a 1 1/8" thick fiberboard core with high pressure laminate top.

DESIGN

The 3/4" bullnose edge-banding is colored to match your choice of nine leg colors.

FLEXIBILITY

Powder-coated legs with chrome-plated inserts adjust in 1" increments to heights from 23" to 32" with two self-locking screws per leg for safety.

OPTIONS

The sky is the limit with nine leg/edge colors and five laminate colors.

Hercules Series – Group-Study and Activity Table



HL-2460 - Rectangular Table
(Shown with custom laminate Wilsonart Blue Agave #49119)



HLEE-4848CLV - Clover Table

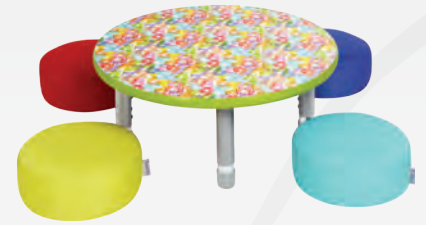

HLSUS-36R - Sushi Table
(Shown with 8104 - (4) Pebble Mod®)

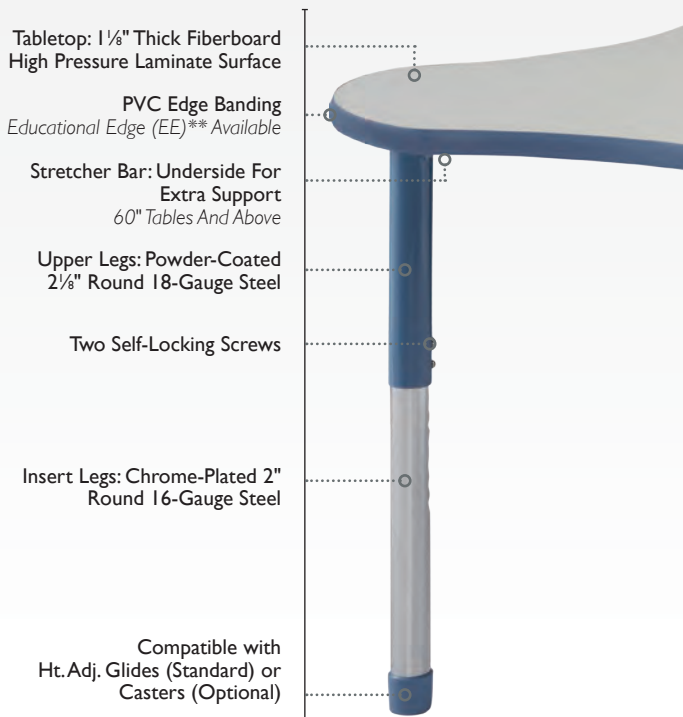

Shapes



	Standard (23-32"H)	Toddler (17-22"H)	Sushi (12-16"H)	W × D"
Rectangular				
HL-2436	HLS-2436	HLSUS-2436		36 × 24"
HL-2448	HLS-2448	HLSUS-2448		48 × 24"
HL-2460	HLS-2460	HLSUS-2460		60 × 24"
HL-2472	HLS-2472	HLSUS-2472		72 × 24"
HL-3048	HLS-3048	HLSUS-3048		48 × 30"
HL-3060	HLS-3060	HLSUS-3060		60 × 30"
HL-3072	HLS-3072	HLSUS-3072		72 × 30"
HL-3660	HLS-3660	HLSUS-3660		60 × 36"
HL-3672	HLS-3672	HLSUS-3672		72 × 36"
Round				
HL-36R	HLS-36R	HLSUS-36R		36 × 36"
HL-42R	HLS-42R	HLSUS-42R		42 × 42"
HL-48R	HLS-48R	HLSUS-48R		48 × 48"
HL-60R	HLS-60R	HLSUS-60R		60 × 60"
Trapezoid				
HL-2448TR	HLS-2448TR	HLSUS-2448TR		24 × 48"
HL-3060TR	HLS-3060TR	HLSUS-3060TR		30 × 60"
Kidney				
HL-3672K	HLS-3672K	HLSUS-3672K		72 × 36"
HL-4872K	HLS-4872K	HLSUS-4872K		72 × 48"
Horseshoe				
HL-6066H	HLS-6066H	HLSUS-6066H		60 × 66"
Square				
HL-3636SQ	HLS-3636SQ	HLSUS-3636SQ		36 × 36"
HL-4848SQ	HLS-4848SQ	HLSUS-4848SQ		48 × 48"
Clover				
HL-4848CLV	HLS-4848CLV	HLSUS-4848CLV		48 × 48"
Flower				
HL-6060FL	HLS-6060FL	HLSUS-6060FL		60 × 60"
Inspiration				
HL-6060PL	HLS-6060PL	HLSUS-6060PL		60 × 60"
Corner				
HL-2460CNR	HLS-2460CNR	HLSUS-2460CNR		60 × 24"
Curved				
HL-4254CUR	HLS-4254CUR	HLSUS-4254CUR		54 × 42"

Optional Items: Bookboxes, Casters, Educational Edge (EE)**, and Grommets.

**Educational Edge (EE): Color coordinated edge banding and legs. Add "EE" to the model number and note the color needed at the time of ordering. Example: HLEE-2448

Standard and Toddler- available with EE, both edge and leg.
Sushi and Standing Height- upper leg available in Black or Gray. Add "EE" to get color coordinated edge only.

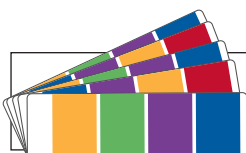

**Colors, Guides,
& Accessories**
See pages 112-117

CLASSROOM TABLE

Harmony Series – Collaborative and Group Study Table



HS-3152CD & HS-3052RY - **Chord and Rhythm Configuration**
(Shown with Formica Amarena #6907 and Spectrum Blue #851, as well as optional Casters)



Adjustable Legs Compatible with Casters or Glides



Underside of Table



Marker-Board Table Top



DESIGN

True to its name, Harmony's 4 options conceive a symmetry of interconnections, evoking the tranquility of waves.



BENEFITS

Brainstorming at its best with any size grouping and Marker Board surface option for jotting down thoughts, calculations, diagrams or doodles.



VERSATILITY

Harmony creates the collaborative concept in traditional classrooms, conference rooms, STEM labs, libraries, affording countless configurations.



STRENGTH

High pressure laminate with a T-mold edging will hold up no matter how many times you regroup.

Harmony Series – Collaborative and Group Study Table



HS-3052RY - Rhythm
(Shown with custom laminates Formica Spectrum Blue #851 and optional Casters)



HS-3152CD - Chord
(Shown with custom laminate Formica Amarena #6907 and optional Casters)



HS-5252TN - Tone
(Shown with custom laminates Formica Spectrum Blue #851 and optional Casters)



HS-5252ML - Melody
(Shown with custom laminate Formica Amarena #6907 and optional Casters)



**V2N-3052-RY
Rhythm Nesting Table**



**V2N-3152-CD
Chord Nesting Table**



**Need help configuring in groups?
Request a complimentary puzzle set.**

Tabletop: 1 1/8" Thick Fiberboard High Pressure Laminate Surface

PVC Edge Banding Educational Edge (EE)* Available

Upper Legs: Powder-Coated 2 1/8" Round 18-Gauge Steel Legs

Two Self-Locking Screws

Insert Legs: Chrome-Plated 2" Round 16-Gauge Steel

Legs Adjust In 1" Increments

Compatible with Ht. Adj. Glides (Standard) or Casters (Optional)



	Standard (23-32"H)	Toddler (17-22"H)	Sushi (12-16"H)	Nesting Table Fix. (29" H)
Shapes				
Rhythm (52 × 30")				
	HS-3052RY	HSS-3052RY	HSSUS-3052RY	V2N-3052-RY
	HSEE-3052RY	HSEES-3052RY	HSSUSEE-3052RY	—
Chord (52 × 31")				
	HS-3152CD	HSS-3152CD	HSSUS-3152CD	V2N-3152-CD
	HSEE-3152CD	HSEES-3152CD	HSSUSEE-3152CD	—
Tone (52 × 52")				
	HS-5252TN	HSS-5252TN	HSSUS-5252TN	—
	HSEE-5252TN	HSEES-5252TN	HSSUSEE-5252TN	—
Melody (52 × 52")				
	HS-5252ML	HSS-5252ML	HSSUS-5252ML	—
	HSEE-5252ML	HSEES-5252ML	HSSUSEE-5252ML	—

Optional Items: Casters*, Educational Edge (EE)**, and Grommets.

*Casters are Standard for Nesting Tables

**Educational Edge (EE) for Tables is color coordinated edge banding and legs. Note the color needed at the time of ordering.

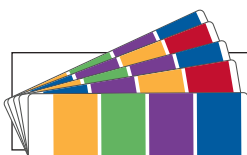

**Colors, Guides,
& Accessories**
See pages 112-117

CLASSROOM TABLE

Dura Series – Collaborative and Group Study Table



WLA-6060AD - Adjustable Height Adam Table
(Shown with custom laminate Formica Matrix Blue #8789)



Fixed and Adjustable Option



Fully Welded
Strong Unitized
Frame

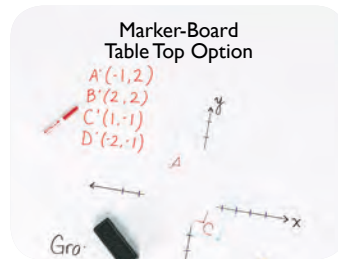

Marker-Board
Table Top Option

STRENGTH

Steel apron (or frame) and legs welded into one solid unit, then gusseted to tabletop produce a table that withstands years of use with total “Dura-bility”.

VERSATILITY

Adjustable height legs allow both adults and little ones to feel at ease. Also available with fixed leg height.

DESIGN

As appealing as a cloud, the Adam table beckons students to find their place, grab a marker and start thinking with a smile. The Chad's straight end can seat the leader, adjoin a wall, or combine with other Chads.

BENEFITS

For 6 students (or 5 plus instructor), the Adam is the perfect collaborative companion to Mod cushioned seats. Students easily see each other for idea sharing. Chad holds 6 students plus teacher.

Dura Series – Collaborative and Group Study Table



WLA-6060FL - **Adjustable Standard Ht. Dura Table**
(Shown with standard laminate White Board)



WLA-2460EE - **Adjustable Standard Ht. Dura Table**
(Shown with Optional Casters)



WLF-4848CLVR - **Fixed Standard Ht. Dura Table**
(Shown with custom with Gray Graphite Chem Res HPL and X-Strong Edge**)

Tabletop: 1/8" Thick Fiberboard High Pressure Laminate Surface

PVC Edge Banding
Educational Edge (EE)* Available

Fully Welded, Unitized Frame:
2" x 1" Rectangular 16-Gauge Steel Frame welded to 1 7/8" Round 16-Gauge Steel Legs

Dura Legs: Available in Black or Tungsten Color

Insert Legs: Chrome-Plated 2" Round 16-Gauge Steel

Available In Four Height Variations

Compatible with Ht. Adj. Glides (Standard) or Casters (Optional)

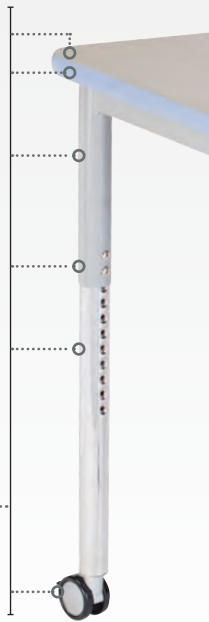

Shapes	Standard Height		Standing Height		W x D"
	Adj. 23-32" H	Fix. 29 1/2" H	Adj. 33-42" H	Fix. 42" H	
	Rectangular				
	WLA-2048	WLF-2048	WLSHA-2048	WLSHF-2048	48 x 20"
	WLA-2060	WLF-2060	WLSHA-2060	WLSHF-2060	60 x 20
	WLA-2072	WLF-2072	WLSHA-2072	WLSHF-2072	72 x 20
	WLA-2436	WLF-2436	WLSHA-2436	WLSHF-2436	36 x 24
	WLA-2448	WLF-2448	WLSHA-2448	WLSHF-2448	48 x 24
	WLA-2460	WLF-2460	WLSHA-2460	WLSHF-2460	60 x 24
	WLA-2472	WLF-2472	WLSHA-2472	WLSHF-2472	72 x 24
	WLA-3036	WLF-3036	WLSHA-3036	WLSHF-3036	36 x 30
	WLA-3048	WLF-3048	WLSHA-3048	WLSHF-3048	48 x 30
	WLA-3060	WLF-3060	WLSHA-3060	WLSHF-3060	60 x 30
	WLA-3072	WLF-3072	WLSHA-3072	WLSHF-3072	72 x 30
	WLA-3660	WLF-3660	WLSHA-3660	WLSHF-3660	60 x 36
	WLA-3672	WLF-3672	WLSHA-3672	WLSHF-3672	72 x 36
	WLA-4260	WLF-4260	WLSHA-4260	WLSHF-4260	60 x 42
	Adam				
	WLA-6060AD	WLF-6060AD	WLSHA-6060AD	WLSHF-6060AD	60 x 60"
	Chad				
	WLA-4260CH	WLF-4260CH	WLSHA-4260CH	WLSHF-4260CH	60 x 42"
	Round				
	WLA-36R	WLF-36R	WLSHA-36R	WLSHF-36R	36 x 36"
	WLA-42R	WLF-42R	WLSHA-42R	WLSHF-42R	42 x 42
	WLA-48R	WLF-48R	WLSHA-48R	WLSHF-48R	48 x 48
	WLA-60R	WLF-60R	WLSHA-60R	WLSHF-60R	60 x 60
	Trapezoid				
	WLA-2448TR	WLF-2448TR	WLSHA-2448TR	WLSHF-2448TR	24 x 48"
	WLA-3060TR	WLF-3060TR	WLSHA-3060TR	WLSHF-3060TR	30 x 60
	Kidney				
	WLA-3672K	WLF-3672K	WLSHA-3672K	WLSHF-3672K	72 x 36"
	WLA-4872K	WLF-4872K	WLSHA-4872K	WLSHF-4872K	72 x 48
	Horseshoe				
	WLA-6066H	WLF-6066H	WLSHA-6066H	WLSHF-6066H	60 x 66"
	Square				
	WLA-4848SQ	WLF-4848SQ	WLSHA-4848SQ	WLSHF-4848SQ	48 x 48"
	Clover				
	WLA-4848CLVR	WLF-4848CLVR	WLSHA-4848CLVR	WLSHF-4848CLVR	48 x 48"
	Flower				
	WLA-6060FL	WLF-6060FL	WLSHA-6060FL	WLSHF-6060FL	60 x 60"

Optional Items: Casters, Educational Edge (EE)*, Power Port, and X-Strong Edge**.

*Educational Edge (EE): color coordinated edge banding. Add "EE" to the model number and note the color needed at the time of ordering. Educational Edge matching legs are not available on Dura Series tables. Example: WLA-2460EE

**X-Strong Edge: Sprayed on polyurea - tough, flexible, waterproof edge coating.

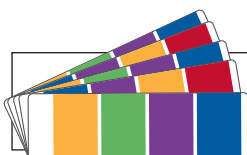

Colors, Guides, & Accessories
See pages 112-117

CLASSROOM TABLE

Activity Series – Group-Study and Activity Table



AL-2448 - Rectangular Activity Table
(Shown with standard laminate Driftwood)

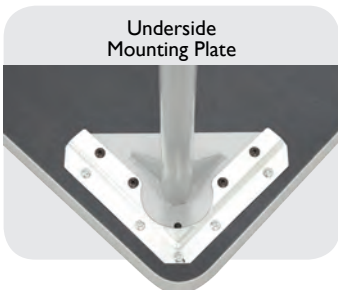

CONSTRUCTION

Made with 1 1/8" - thick fiberboard core and a high-pressure laminate top. Includes heavy-gauge steel legs with underside mounting brackets.

FLEXIBILITY

Powder-coated legs with chrome-plated inserts adjust in 1" increments to heights from 22" to 29" (toddler height 17" to 22") with two self-locking screws for safety.

EDGE BANDING

Whether selecting the standard black or gray edge banding, or choosing from the Educational Edge colors, the 3/4" bullnose resists chipping for years of use.

COLORS

Table surface available in your choice of five laminate options. Additional colors available upon request.

Activity Series – Group-Study and Activity Table



AL-48R - **Round Activity Table**
(Shown with custom laminate
Formica Gray Joseph Linen #6325)



AL-2448TR - **Trapezoid Activity Table**
(Shown with custom laminate
Formica Gray Joseph Linen #6325)



Shapes	Standard (23-31" H)	Toddler (17-22" H)	W x D"
	Rectangular		
	AL-2430	ALS-2430	30 x 24"
	AL-2436	ALS-2436	36 x 24
	AL-2448	ALS-2448	48 x 24
	AL-2460	ALS-2460	60 x 24
	AL-2472	ALS-2472	72 x 24
	AL-3048	ALS-3048	48 x 30
	AL-3060	ALS-3060	60 x 30
	AL-3072	ALS-3072	72 x 30
	AL-3660	ALS-3660	60 x 36
	AL-3672	ALS-3672	72 x 36
		Round	
AL-36R		ALS-36R	36 x 36"
AL-42R		ALS-42R	42 x 42
AL-48R		ALS-48R	48 x 48
AL-60R		ALS-60R	60 x 60
	Trapezoid		
	AL-2448TR	ALS-2448TR	24 x 48"
AL-3060TR	ALS-3060TR	30 x 60	
	Kidney		
	AL-3672K	ALS-3672K	72 x 36"
AL-4872K	ALS-4872K	72 x 48	
	Horseshoe		
AL-6066H	ALS-6066H	60 x 66"	
	Square		
	AL-3636SQ	ALS-3636SQ	36 x 36"
AL-4848SQ	ALS-4848SQ	48 x 48	
	Clover		
AL-4848CLV	ALS-4848CLV	48 x 48"	
	Flower		
AL-6060FL	ALS-6060FL	60 x 60"	

Optional Items: Bookboxes, Educational Edge (EE)*, Glide Caps (Felt, Rubber and Steel), Grommets, and Power Port.

*Educational Edge (EE): Color coordinated edge banding and legs. Add "EE" to the model number and note the color needed at the time of ordering. Example: ALEE-36R

Colors, Guides, & Accessories
See pages 112-117

CLASSROOM TABLE



BLOOMFIELD HIGH SCHOOL - BLOOMFIELD, NJ



Inspiration Series – School Chair
Harmony Series – Chord and Rhythm Tables

CLASSROOM TABLE

Demonstration Series – STEM Table



DHFBB-3060 - Butcher Block
Demonstration Table
(Shown with optional casters)



STRENGTH

Fully welded steel frame engineered to withstand the most hands-on classroom training.

VERSATILITY

Science, technology, engineering or kitchens, this table fits right in.

DESIGN

Sit or stand, you choose! This table was designed with comfort in mind. Four height variations are available.

BENEFITS

Select from wide range of tabletop options. Perfect for all STEM & Culinary environments. We offer Butcher Block, Epoxy, Stainless Steel or Phenolic tops.

Demonstration Series – STEM Table

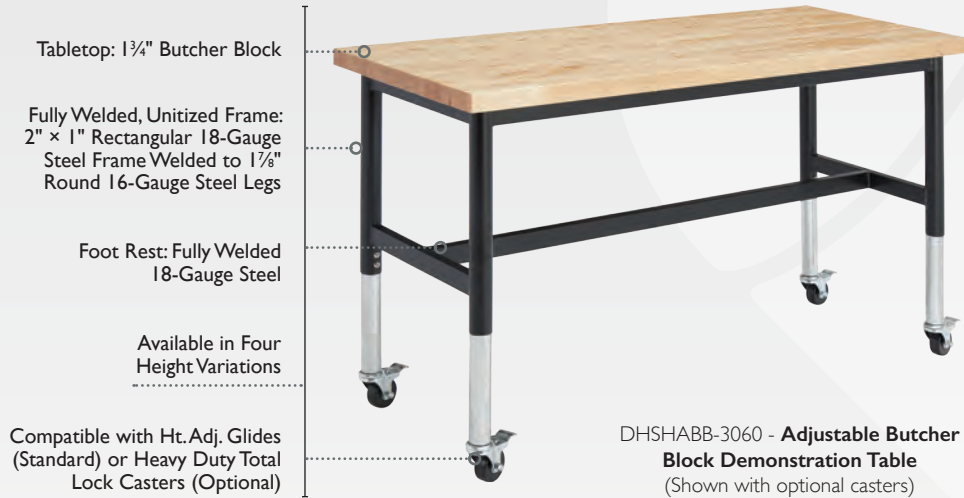

Standard Height		W x D"
Adj. 23-32" H	Fix. 29½" H	
Butcher Block Top		
DHABB-2460	DHFBB-2460	60 x 24"
DHABB-3060	DHFBB-3060	60 x 30
DHABB-3660	DHFBB-3660	60 x 36
DHABB-4260	DHFBB-4260	60 x 42
Phenolic Top		
DHAP-2460	DHFPP-2460	60 x 24"
DHAP-3060	DHFPP-3060	60 x 30
DHAP-3660	DHFPP-3660	60 x 36
DHAP-4260	DHFPP-4260	60 x 42
Epoxy Top		
DHAE-2460	DHFE-2460	60 x 24"
DHAE-3060	DHFE-3060	60 x 30
DHAE-3660	DHFE-3660	60 x 36
DHAE-4260	DHFE-4260	60 x 42



Standing Height		W x D"
Adj. 33-42" H	Fix. 42" H	
Butcher Block Top		
DHSHABB-2460	DHSHFBB-2460	60 x 24"
DHSHABB-3060	DHSHFBB-3060	60 x 30
DHSHABB-3660	DHSHFBB-3660	60 x 36
DHSHABB-4260	DHSHFBB-4260	60 x 42
Phenolic Top		
DHSHAP-2460	DHSHFPP-2460	60 x 24"
DHSHAP-3060	DHSHFPP-3060	60 x 30
DHSHAP-3660	DHSHFPP-3660	60 x 36
DHSHAP-4260	DHSHFPP-4260	60 x 42
Epoxy Top		
DHSHAE-2460	DHSHFE-2460	60 x 24"
DHSHAE-3060	DHSHFE-3060	60 x 30
DHSHAE-3660	DHSHFE-3660	60 x 36
DHSHAE-4260	DHSHFE-4260	60 x 42

Optional Items: Casters & Stainless Steel Tabletops.

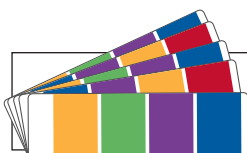

**Colors, Guides,
& Accessories**
See pages 112-117

CLASSROOM TABLE

Demonstration Series – STEM Workstation



DWC42-5252 - **STEM Work Station**
(Shown with custom laminate Formica
Burnt Strand and Z58D - Drafting Stool)



Optional X-Strong Edge



STRENGTH

Strong laminate options, including custom Chem Res HPL, X-Strong Edge, etc. Locking casters secure position or glide for quick rearranging or clean-up.

DESIGN

Alternating concave and convex curves, this uniquely-shaped table maximizes leg room and workspace for today's hands-on learning.

VERSATILITY

Highly customizable with adjustable shelving, tote bins and power options. Wide array of color choices, easy and lightweight for mobility. Available in 30", 36" and 42" height options.

BENEFITS

Large, durable work surface accommodates 4 --sitting or standing -- for experiential education needs. Tote bins are compatible with Tote Bin Cabinet as well as desks and tables. Convenient for keeping supplies close by for immediate access.

Demonstration Series – STEM Workstation



DWC42-5252 - **STEM Work Station**
(Shown with custom Chem Res HPL, Tote Bins and Shelves)



TBC-4342 - **Tote Bin Cabinet**
(Shown with optional Clear Bins)

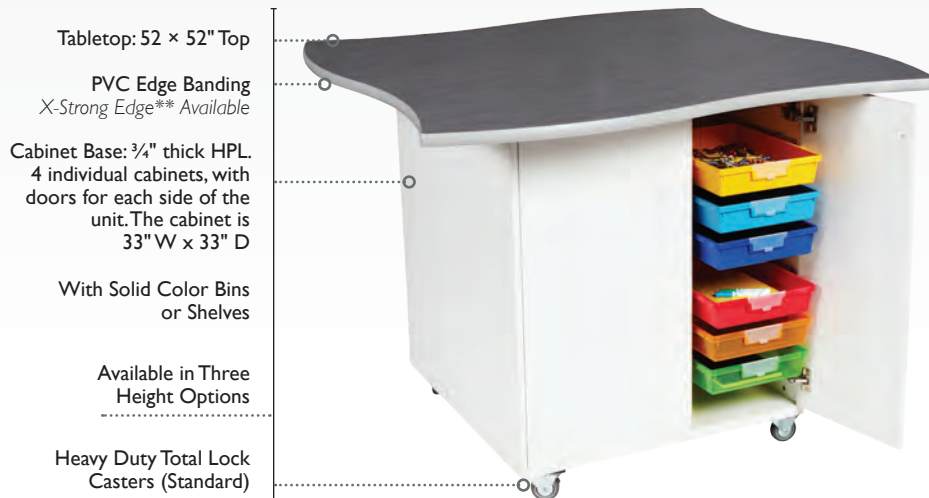

Tabletop: 52" x 52" Top

PVC Edge Banding
X-Strong Edge** Available

Cabinet Base: 3/4" thick HPL.
4 individual cabinets, with doors for each side of the unit. The cabinet is 33" W x 33" D

With Solid Color Bins or Shelves

Available in Three Height Options

Heavy Duty Total Lock Casters (Standard)

DWC42-5252 - **STEM Work Station**
(Shown with custom laminate Formica Burnt Strand and Tote Bins)

Model	Table Ht.	Bins/Side	W x D"
With Tote Bins			
DWC30-5252	30"	3	52 x 52"
DWC36-5252	36"	4	52 x 52"
DWC42-5252	42"	6	52 x 52"

Model	Table Ht.	Shelves/Side	W x D"
With Shelves			
DW30-5252	30"	1	52 x 52"
DW36-5252	36"	2	52 x 52"
DW42-5252	42"	2	52 x 52"

Model	Ht.	Bins	W x D"
Tote Bin Cabinet			
TBC-4342	42"	27	43 x 13"

Optional Items: Clear Bins, Power Port, Shelves or Tote Bins*, and X-Strong Edge**.

*Color options for Tote Bins are available on Page 117

**X-Strong Edge: Sprayed on polyurea - tough, flexible, waterproof edge coating.

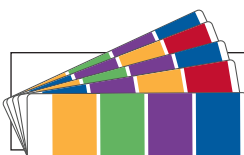

Colors, Guides, & Accessories
See pages 112-117

Illustration V2 Series – Seminar and Computer Table



V2NMP-3060 - V2N Fixed Nesting Table with Modesty Panel

Matching Options



Illustration V2 Adjustable Desk
See page 34-35



Illustration V2 Fixed Desk
See page 34-35

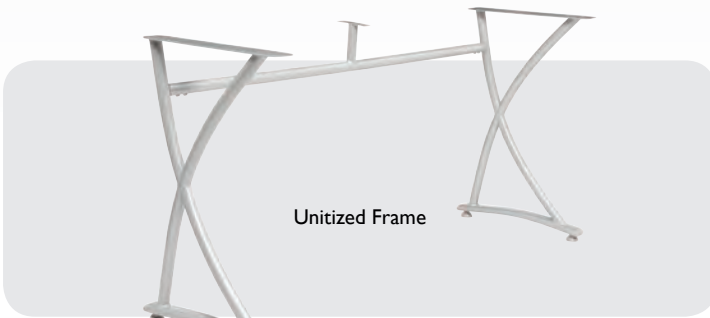

Unitized Frame



One Hand Lever Mechanism



V2N Nesting Table Group w/ Modesty Panel

Close when not in use for more space!

COMFORT

The table can be used in any setting thanks to the legs which can be adjusted to heights from 26"-31".

DESIGN

The soft curves of the upper leg supports and dual legs on either side make this table the design of the future.

BENEFITS

The 1150+ square inch tabletop is designed to provide plenty of room for displays, keyboards, mouse and accessories.

STRENGTH

The unitized frame is self-supporting, meaning that the table is held together by heavy-gauge steel, not by the top.

Illustration V2 Series – Seminar and Computer Table

Tabletop: 1 1/8" Fiberboard High-Pressure Laminate Surface

Edge-Banding

Legs: Two 1 1/2" Diameter Tubes 16-Gauge Steel

Welded Connection: 1" Steel Tube, 12-Gauge Steel, welded to 1 1/4" Diameter 18 Gauge Steel Strecher Bar

Compatible with Ht. Adj. Glides (Standard) or Casters (Optional)



V2F-2460 - **Illustration V2 Fixed Seminar Table**
(Shown with custom laminate Pionite Chocolate Malt #WC210)

Adjustable (27 1/2"-31 1/2" H)	Fixed (29" H)	W x D"
Seminar Table		
V2A-2048	V2F-2048	48 x 20"
V2A-2060	V2F-2060	60 x 20
V2A-2072	V2F-2072	72 x 20
V2A-2436	V2F-2436	36 x 24
V2A-2448	V2F-2448	48 x 24
V2A-2460	V2F-2460	60 x 24
V2A-2472	V2F-2472	72 x 24
V2A-3036	V2F-3036	36 x 30
V2A-3048	V2F-3048	48 x 30
V2A-3060	V2F-3060	60 x 30
V2A-3072	V2F-3072	72 x 30

Grommets

Upper Legs: Two 1 1/2" Diameter Tubes 16-Gauge Steel

Wire Management

Insert Legs: Two 1 1/8" Diameter, 16-Gauge Steel Chrome Legs



V2CO-2460 - **Illustration V2 Adjustable Height Computer Table**
(Shown with custom laminate Pionite Chocolate Malt #WC210)

Adjustable (27 1/2"-31 1/2" H)	Fixed (29" H)	W x D"
Computer Table		
V2ACO-2436	V2FCO-2436	36 x 24
V2ACO-2448	V2FCO-2448	48 x 24
V2ACO-2460	V2FCO-2460	60 x 24
V2ACO-2472	V2FCO-2472	72 x 24
V2ACO-3036	V2FCO-3036	36 x 30
V2ACO-3048	V2FCO-3048	48 x 30
V2ACO-3060	V2FCO-3060	60 x 30
V2ACO-3072	V2FCO-3072	72 x 30

Spring Loaded Auto-Lock Handle in Open/Closed Positions

2 Rectangular Steel Bars 1 1/2 x 3/4"

Torsion Bar Connects The Table Top & Leg Frame Allows for a Slow And Safe Close



V2N-3060 - **V2N Nesting Table Fixed**
(Shown with custom laminate Pionite Chocolate Malt #WC210)

Model	W x D"
Nesting Table Fixed (29"H)	
V2N-2448	48 x 24"
V2N-2460	60 x 24
V2N-2472	72 x 24
V2N-3048	48 x 30
V2N-3060	60 x 30
V2N-3072	72 x 30
Nesting Table Fixed w/ Modesty Panel (29"H)	
V2NMP-2448	48 x 24"
V2NMP-2460	60 x 24
V2NMP-2472	72 x 24
V2NMP-3048	48 x 30
V2NMP-3060	60 x 30
V2NMP-3072	72 x 30

Optional Items: Casters (Standard on all V2N), CPU Stand, Grommets, Keyboard Trays, Wire Management, and Rubber Glides. Modesty Panel optional on V2N.

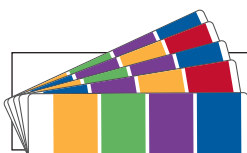

Colors, Guides, & Accessories
See pages 112-117

CLASSROOM TABLE

C-Leg Series – Computer Table



CL-2448 - Computer Table
(Shown with custom Nevamar #WM0047 Tabletop
& optional Power Port)



DESIGN

This traditionally designed table now features a modern looking perforated modesty panel. The C-Legs offer excellent support with built-in wire management.



BENEFITS

Available in many widths and depths to accommodate varying numbers of students and a full array of computer equipment. Perforated modesty panel allows for improved airflow.



OPTIONS

To make the most of these tables, we've included grommets and choice of optional keyboard trays and computer holders.

C-Leg Series – Computer Table



CL-2448 - Computer Table
(Shown with custom Nevamar #WM0047 Tabletop)

Standard Grommets
Tabletop: 1/8" Thick Fiberboard
High-Pressure Laminate Surface

Edge-Banding

18-Gauge Modesty Panel With
Built-In Wire Management Tray

Frame: 17-Gauge Black Powder-
Coated Rectangular Tubing
1 1/8" x 2 1/8"

Height Adjustable Screw-In
Nylon Glides



CL-2436 - Computer Table
(Shown with custom Nevamar #WM0047 Tabletop & grommet)

Model	Table Height	W x D"
Computer Tables		
CL-2430	29 1/2"	30 x 24"
CL-2436	29 1/2"	36 x 24
CL-2448	29 1/2"	48 x 24
CL-2460	29 1/2"	60 x 24
CL-2472	29 1/2"	72 x 24
CL-3036	29 1/2"	48 x 30
CL-3048	29 1/2"	48 x 30
CL-3060	29 1/2"	60 x 30
CL-3072	29 1/2"	72 x 30

Store your peripherals and
supplies or even add another
workstation—make the most
out of your space.



CL-48CRN - Corner Computer Table
(Shown with custom Nevamar #WM0047 Tabletop)

Model	Table Height	W x D"
Corner Unit		
CL-42CRN	29 1/2"	42 x 42"
CL-48CRN	29 1/2"	48 x 48

Optional Items: Casters, CPU Holder, CPU Stand, Connector Bridge, Keyboard Tray, Power Supply and Rubber Glides.

Corner table not available with a Light Gray frame finish.

Grommets and wire management are standard on all C-Leg tables.

Depending on the width, one, two or three computer workstations can comfortably fit on each table. See the chart on Page 117 for more information.

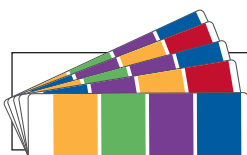

**Colors, Guides,
& Accessories**
See pages 112-117

CLASSROOM TABLE

T-Leg Series – Computer and Seminar Table



Matching Options



T-Leg Desk
See page 36-37

TL-2460 - T-Leg Computer Table
(Shown with custom laminate Wilsonart Beigewood #7850, optional Grommets, Keyboard Trays and Wire Management Tray)

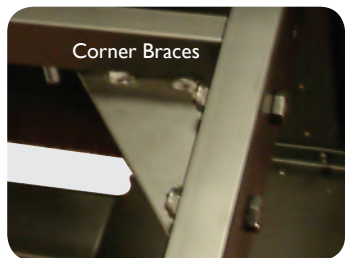
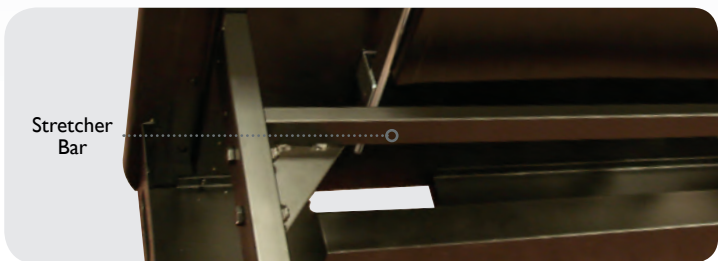

BENEFITS

These entry-level computer tables are designed to be durable yet inexpensive. Wide selection of widths, depths and surface colors.



DESIGN

Features a sturdy T-leg design which is secured by three self-locking screws and adjustable to heights from 22" to 33".



STRENGTH

The understructure is a unitized frame which makes these tables very sturdy. Larger-size tabletops include stretcher bars for added strength.



OPTIONS

Keyboard tray, computer holders and wire-management trays can be added to any table in this series.

T-Leg Series – Computer and Seminar Table

Tabletop: 1/8" Thick Fiberboard High-Pressure Laminate Surface

Black PVC Edge-Banding

Upper Legs: 16-Gauge Black Powder-Coated Rectangular Tubing
1 1/8"W x 2 1/8"D

Three Self-Locking Screws
Insert Legs: 16-Gauge Chrome-Plated Rectangular Tubing
1"W x 2"D

Height Adjustable Screw-In Nylon Glides



TL-2448 - Seminar Table
(Shown with custom laminate Wilsonart Beigewood #7850)

Model	Table Height	W x D"
Computer Tables		
TL-2436	22 1/2-32 1/2"	36 x 24"
TL-2448	22 1/2-32 1/2"	48 x 24
TL-2460	22 1/2-32 1/2"	60 x 24
TL-2472	22 1/2-32 1/2"	72 x 24
TL-3036	22 1/2-32 1/2"	36 x 30
TL-3048	22 1/2-32 1/2"	48 x 30
TL-3060	22 1/2-32 1/2"	60 x 30
TL-3072	22 1/2-32 1/2"	72 x 30
TL-3660	22 1/2-32 1/2"	60 x 36
TL-3672	22 1/2-32 1/2"	72 x 36



ADA Version Shown



TLADA-2436 - ADA Accessibility Seminar Table
(Shown with custom laminate Wilsonart Beigewood #7850)

Model	Table Height	W x D"
ADA Accessible		
TLADA-2436	30-35"	36 x 24"
TLADA-2448	30-35"	48 x 24
TLADA-2460	30-35"	60 x 24
TLADA-2472	30-35"	72 x 24
TLADA-3048	30-35"	48 x 30
TLADA-3060	30-35"	60 x 30
TLADA-3072	30-35"	72 x 30
TLADA-3660	30-35"	60 x 36
TLADA-3672	30-35"	72 x 36

Optional Items: Casters, CPU Holder, CPU Stand, Grommets, Keyboard Tray, Rubber Glides and Wire Management Tray.

T-Leg Tables not available with a Light Gray frame finish.

Grommets and wire management not standard.

Depending on the width, one, two or three computer workstations can comfortably fit on each table. See the chart on Page 117 for more information.

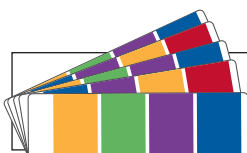

Colors, Guides, & Accessories
See pages 112-117



DR. KIRAN C. PATEL HIGH SCHOOL - TEMPLE TERRACE, FL



Zed Series – Cantilever Chairs
Boost Series - High Café Stools and Round & Square Cafe Table
The Mod Series®

Student Lounge – The Mod Series®



8728 - Arc 6 Mod® with 8020SQ - Mod® Table



Configure in Groups

8138 - Round 30 Mod® with 8200 - Semi Round Mod®

COMFORT

Cushiony and cozy, the high density foam provides a welcome soft-seating change from traditional chairs.

STRENGTH

Unique steel peg, concealed casters slide effortlessly. Heavy plywood base makes the Mod® virtually un-tippable.

DESIGN

Vibrantly enhancing any room with inviting relaxation, the Mod® is available in three Momentum Textile grade choices, endless colors, including water-resistant, pen-resistant and antibacterial options.

VERSATILITY

With 8 shape and 2 height options, any room can become a haven of adaptability as Mod® options work individually as well as in limitless configurations.



Add Custom Logo

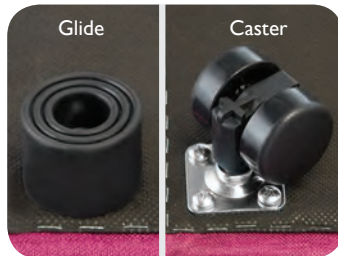

Glide

Caster

Student Lounge – The Mod Series®



8100 - Round Mod®



8300 - Square Mod®



8400 - Square Corner Mod®



8500 - Hexagon Mod®



8700 - Arc Corner Mod® with Café Table



8600 - Rectangular Mod®

Seat: Polyurethane Foam Core
With 1/2" Plywood Frame
Supported by Multiple 1 X 2
Wooden Pegs

Mod® comes standard
with casters. Stationary
Glides may be requested
as an alternate option
when ordering.

Four 1 1/2" Twin Wheel Caster

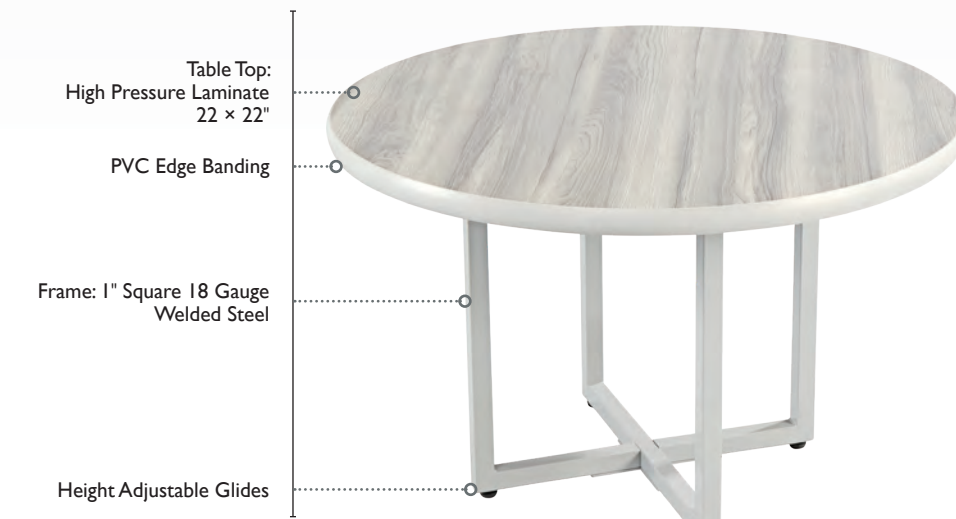

8030R - Mod® Table
(Shown with laminate Driftwood)

Table Top:
High Pressure Laminate
22 x 22"

PVC Edge Banding

Frame: 1" Square 18 Gauge
Welded Steel

Height Adjustable Glides

Shapes	Model	Seat Height"	W x D"
	Mod® Table -8000		
	8020SQ	18 1/2"	22 x 22"
	8030R	18 1/2"	30 x 30
	Round -8100		
	8114	13 1/2"	13 x 13"
	8118	17 1/2"	17 x 17
	8138	18"	30 x 30
	Semi-Round -8200		
	8214	13 1/2"	13 x 13"
	8218	17 1/2"	17 x 17
	Square -8300		
	8314	13 1/2"	13 x 13"
	8318	17 1/2"	17 x 17
	Square Corner -8400		
	8414	13 1/2"	13 x 13"
	8418	17 1/2"	17 x 17"
	Hexagon -8500		
	8514	13 1/2"	13 x 13"
	8518	17 1/2"	17 x 17
	Rectangle -8600		
	8614	13 1/2"	26 x 13"
	8618	17 1/2"	34 x 17
	Arc Corner -8700		
	8714	13 1/2"	51 x 20 1/2"
	8718	17 1/2"	56 1/2 x 24 3/4"
	Arc 6 -8700		
	8728	18"	44 x 18"

Textile Options Available from



Optional Items: Place your School Logo on The Mod®, Stationary Glides.

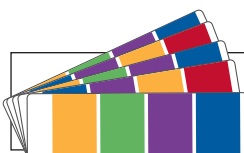

Colors
Contact us to
Request Swatches

Student Lounge – The Mod Series®

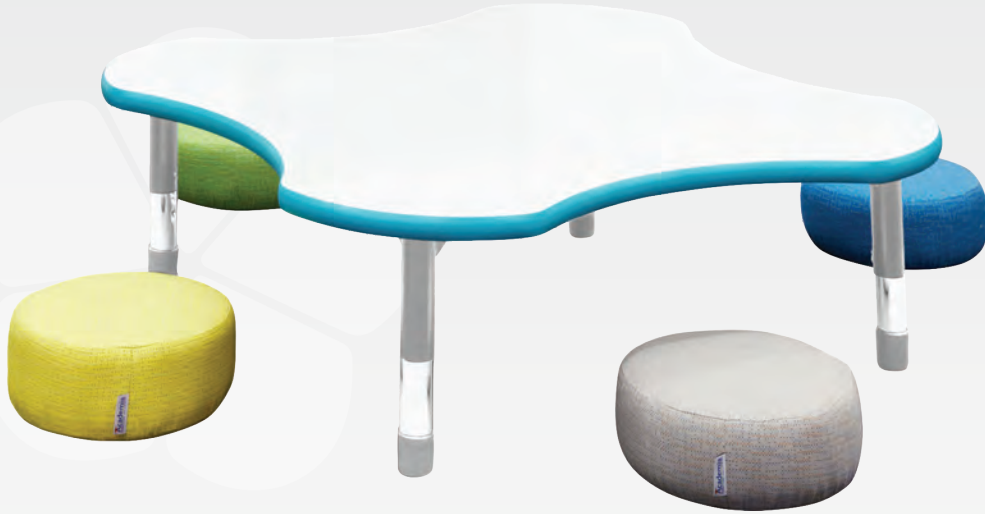

8104 - **(4) Pebble Mod®**
(Shown with HLSUS-48CLVR - Sushi Table)

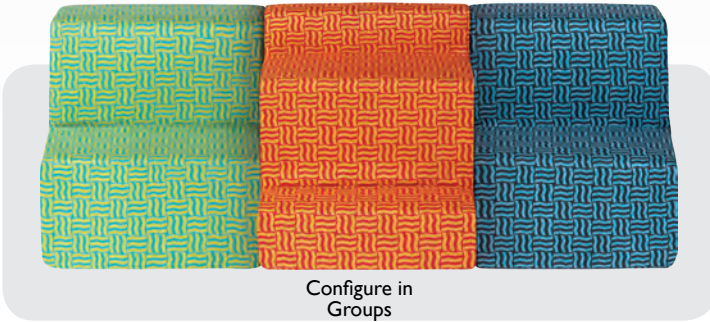

Configure in
Groups



Add Custom Logo

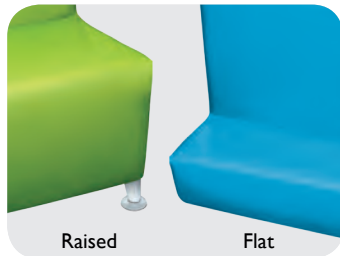

Raised

Flat

 **COMFORT**

Cushiony and cozy, the high density foam provides a welcome soft-seating change from traditional chairs.

 **STRENGTH**

Unique steel peg, concealed casters slide effortlessly. Heavy plywood base makes the Mod® virtually un-tippable.

 **DESIGN**

Vibrantly enhancing any room with inviting relaxation, the Mod® is available in three Momentum Textile grade choices, endless colors, including water-resistant, pen-resistant and antibacterial options.

 **VERSATILITY**

Any room can become a haven of adaptability as Mod® options work individually as well as in limitless configurations.

Student Lounge – The Mod Series®



8628 - 1/4 Back Mod®



8648 - 3/4 Back Mod®



8818 - 2 Step Mod®



8828 - 3 Step Mod®

Seat: Polyurethane Foam Core
With 1/2" Plywood Frame
Supported by Multiple
1 X 2 Wooden Pegs

Textiles: 15 antibacterial
Momentum options
in endless colors

Legs Available on
1/4 Back & 3/4 Back Only



8628 - 1/4 Back Mod®

Shapes



Model **Seat Height"** **W x D"**

1/4 Back w/ Legs

8628 25 1/2" 36 x 24"



3/4 Back w/ Legs

8648 3 1/2" 36 x 26"



2 Step

8818 36" 36 x 36"



3 Step

8828 36" 36 x 36"



Pebble

8104 4 1/2" 14 x 14"

Seat: Polyurethane Foam Core
With 1/2" Plywood Base

Textiles: 15 antibacterial
Momentum options
in endless colors

Nail Glide Underneath



8104 - Pebble Mod®

Textile Options Available:

Grade 1 - Vinyl, Grade 2 - Crypton,
Grade 3 - Silica



Variety of vinyl and fabric options available
from Momentum Textiles.

Optional Items: Place your School Logo
on The Mod®

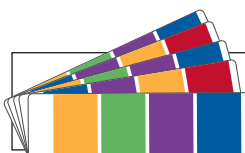

Colors
Contact us to
Request Swatches





STAX Curved Bookcase
Hercules Series - Curved Table
Squirele® - Active Seating Stool

STAX Curved Bookcase – Single and Double-Sided Bookcase



BCURM-6048 - **Stax Curved Single Bookcases**
 (Shown with custom laminate Panolam Shelves - WP500 S'mores,
 Panolam exterior and interior - WX240 Electro Prinatre)

Matching Options



Hercules Curved Table
 See page 70-71



Arc 6 Mod®
 See page 92-93



Adjustable Shelves
 Securely Held by
 Push Pins

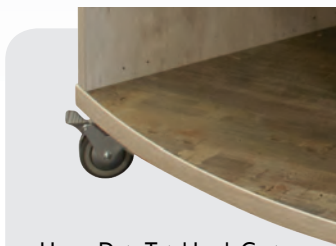

Heavy Duty Total Lock Casters



Back View



VERSATILITY

Single and double sided options available, with casters for mobility as an option. Arrange to create seating nook, reading section, or double as room divider.



STRENGTH

Extra thick shelves and sides made to endure weight; won't sag. All shelves are fully adjustable with counter sunk holes for stability.



BENEFITS

Simple, strong and functional. Solid back. Industrial-grade steel frame on all mobile units.



DESIGN

Curved bookcases, single or double, can combine to create an "S", horseshoe, circle or semicircle shape. Pair with our Arc 6 Mod® for a comfy place to sit in a library, media center or classroom.

STAX Curved Bookcase – Single and Double-Sided Bookcase



BCURDM-6048 - **Stax Curved Double Bookcases**



BCURM-6048 - **Stax Curved Single Bookcases**
(Shown with HLS-4254CUR - Hercules Curved Table & SQ-18 - Squirle® Stools)



BCURM-6048 - **Stax Curved Bookcases**
(Shown with custom laminate Panolam Shelves - WP500 S'mores, Panolam exterior and interior - WX240 Electro Prinatre)

Model	Height"	W x D"
Single Bookcases		
BCURM-6036	36"	60 x 12"
BCURM-6042	42	60 x 12
BCURM-6048	48	60 x 12
Double Bookcases		
BCURDM-6036	36"	60 x 24"
BCURDM-6042	42	60 x 24
BCURDM-6048	48	60 x 24

*All standard laminate Bookcases have matching PVC Edge Banding, except Gray Nebula, which comes standard with Black Edge Banding.

White Board Laminate color is not standard on Bookcases.

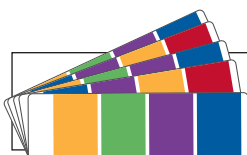

**Colors, Guides,
& Accessories**
See pages 112-117

STAX Bookcase – Single and Double-Sided Bookcase



Stax Bookcases

Various sizes, available in both single and double-sided
(Shown with custom laminate Formica White Malachite #9949)



Adjustable Shelves
Securely Held by
Push Pins



Self-Leveling Glides



Heavy-Duty Steel Frame



VERSATILITY

Single and double sided options available, with casters for mobility as an option. Arrange to create seating nook, reading section, or double as room divider.



STRENGTH

Extra thick shelves and sides made to endure weight; won't sag. All shelves are fully adjustable with counter sunk holes for stability.



BENEFITS

Simple, strong and functional. Solid back. Industrial-grade steel frame on all mobile units.



DESIGN

Simple, strong and functional. Customize colors to match a classroom or media center.

STAX Bookcase – Single and Double-Sided Bookcase



BCD-3648 - Double-Sided Bookcase
(Shown with custom laminate Formica White Malachite #9949)



*Shelves Are Adjustable
(All bookcases 60" and above
have a fixed shelf. Amount of
shelves change depending on
the overall size of the bookcase.)*

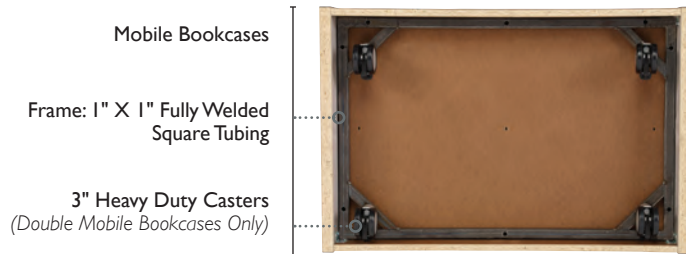

BCDM-3648 - Double Mobile Bookcase
(Underside shown)

Model	Height"	W x D"
Single Bookcases		
BC-3636	36"	36 x 12"
BC-3648	48	36 x 12
BC-3660	60	36 x 12
BC-3672	72	36 x 12
BC-3684	84	36 x 12

Model	Height"	W x D"
Double Bookcases		
BCD-3636	36"	36 x 24"
BCD-3648	48	36 x 24
BCD-3660	60	36 x 24
BCD-3672	72	36 x 24
BCD-3684	84	36 x 24

Model	Height"	W x D"
Double Mobile Bookcases		
BCDM-3636	36"	36 x 24"
BCDM-3648	48	36 x 24

*All standard laminate Bookcases have matching PVC Edge Banding, except Gray Nebula, which comes standard with Black Edge Banding.

White Board laminate color is not standard on bookcases.

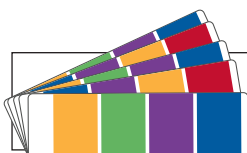

**Colors, Guides,
& Accessories**
See pages 112-117



BLOOMFIELD HIGH SCHOOL - BLOOMFIELD, NJ



Boost Series – Square Café Tables & Zed Café Stools
STAX Curved Bookcases
The Mod Series® – Arc

Boost Series – Café Tables & Stools



CSHF-42R & Z430 - 42" Round Café Table & 30" Café Stool
(Shown with custom laminate Formica White Marble Herringbone 9310 and optional Power Port)

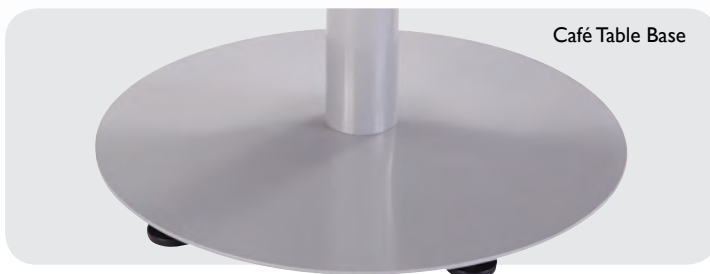

BENEFITS

Comfortable coffee shop ambiance lets students work, collaborate or just socialize. Recharge devices and revitalize readiness for class.



VERSATILITY

Perk up media center or student lounge; 3 table top sizes, 6 standard colors. Many custom colors available to mix or match.



DESIGN

Appealing café height table with curved chairs calls kids to come relax, connect, unwind.



STRENGTH

Strong and sturdy with foot rest for secure sitting; Full contact weld holds up to years of wear.

Boost Series – Café Tables & Stools



CF-30R - Round
Café Tables



CFSH-30R - Standing Height Round
Café Tables



CF-3030SQ- Square
Café Tables



CFSH-3030SQ - Standing Height Square
Café Tables

- Table Top:
1 1/8" Particleboard Core
1/32" High Pressure Laminated
- Backer Sheet:
Underside .020" Poly
- PVC Edge Banding
- Frame: Four 16-Gauge Plate
Attached to Tabletop by 16
Screws
- Frame Finish: Available in
Black or Tungsten
- Legs: 16 Gauge
3 1/2" Diameter
- Base: 12-Gauge
22" Diameter
- Adjustable 2" Rubber Glide



CFSH-3672OV - **Oval Café Table**
(Shown with custom laminate Formica White Marble
Herringbone 9310 and optional Power Port)

Model	Table Height"	W x D"
-------	---------------	--------

Round Café Tables

CF-30R	30"	30"
CF-36R	30	36
CF-42R	30	42
CFSH-30R	42	30
CFSH-36R	42	36
CFSH-42R	42	42

Square Café Tables

CF-3030SQ	30"	30 x 30"
CF-3636SQ	30	36 x 36
CFSH-3030SQ	42	30 x 30
CFSH-3636SQ	42	36 x 36

Oval Double Base Café Tables

CF-3660OV	30"	36 x 60"
CF-3672OV	30	36 x 72
CFSH-3660OV	42	36 x 60
CFSH-3672OV	42	36 x 72

Model	Seat Height"	W x D"
-------	--------------	--------

Inspiration Café Stools

7424	24"	19 1/2 x 22 1/2"
7430	30	19 1/2 x 22 1/2"

Zed Café Stools

Z424	24"	19 1/2 x 22 1/2"
Z430	30	19 1/2 x 22 1/2"

Gray Powder Coating (G)*: To request, add "G" to the model when ordering.
Example: Z424G

Black Powder Coating (B)*: To request, add "B" to the model when ordering.
Example: Z424B

Optional Items: Power Port, Glide Caps (Felt, Rubber and Steel).

Stool height listed is within 3/4" variants.

- Built-in Carry Handle
- Lumbar Support
Smooth Back
- Shell: One-Piece, Color-
Impregnated Polypropylene
Molded Plastic
- Steel Legs: Fully Unitized
14-Gauge, 1" Diameter
(Available in Chrome-Plated,
Gray (G) Powder Coating or
Black (B) Powder Coating)
- Steel Foot Rest: Angled
14-Gauge, 3/4" Diameter
- Self Leveling Nylon Glides



Z430G - **30" High Café Stool**
(Shown with optional
Powder Coated Legs in Gray)

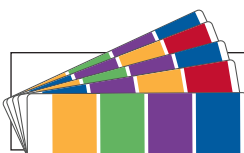

**Colors, Guides,
& Accessories**
See pages 112-117

Study Carrel Series – Study Carrel



SCTL-3660 - **Quad Study Carrel**
(Shown with custom laminate Formica Ashen Ribbonwood 8839 & marker board laminate for work surface)



Stable T-Leg



Easy Assembly with Dowels

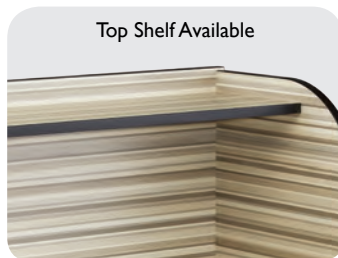

Top Shelf Available



BENEFITS

Dramatic improvements in students' focus and clarity by minimizing distractions. Students close enough for accurate supervision, yet separate enough to ensure individual achievement.



DESIGN

Available in units of 1, 2 or 4, the carrel boasts a virtually disturb-proof, compact configuration of soft, clean, sound-absorbing partitions between each amply-spaced desk.



STRENGTH

Sturdy 16-gauge steel on a heavy-duty frame features strong connective nuts and bolts. Adjusts to your height specs.



VERSATILITY

Triples as a secure testing environment, private study/reading area or distraction-free computer work module.

Study Carrel Series – Study Carrel



SCTL-2460 - Double Study Carrel
 (Shown with custom laminate Formica Ashen Ribbonwood 8839 & marker board laminate for work surface)



SCTL-2436 - Single Study Carrel

Model	Desk Height"	W × D"
Single Study Carrel		
SCTL-2436	22½-32½"	36 × 24"
Double Study Carrel		
SCTL-2460	22½-32½"	60 × 24"
Quad Study Carrel		
SCTL-3660	22½-32½"	60 × 36"

Study Carrels not available with a Light Gray frame finish.

White Board Laminate color is not standard on Study Carrels.

*Top shelf not available on Quad Study Carrels.

**All Study Carrels have standard Black Edge Banding.

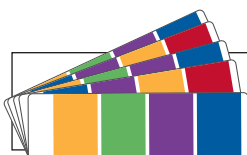

**Colors, Guides,
 & Accessories**
 See pages 112-117

Mobile Easel

Frame: Unitized 1" Square Steel Tubing, Powder-Coated

Dry-Erase Board: Porcelain Magnetic Marker Board Encased In Metal Frame 30" x 30"

Tray Supports: Steel Frame 23 1/4"W x 28"D

Tray: 4 - Rectangular Plastic Holding Removable Trays 9" x 12" x 3"

4 - Standard 2" Heavy-Duty Locking Casters

32"W x 25"D x 54"H



7700 - Mobile Easel
(Accessories shown not included)

Model	Height"	W x D"
Mobile Easel		
7700	54"	32 x 25"



Unitized Frame



Storage Compartments



Locking Casters

 DESIGN

Double-sided unit boasts magnetic porcelain board, with marker trays on each side and four colorful, handy, removable bins.

 STRENGTH

Unlike flimsy easels, our super strong frame and durable wipe-off board will last for years to come.

 VERSATILITY

Four sure-locking casters take your easel anywhere, securely and easily.

 BENEFITS

Our non-protruding base will not tip over nor trip anyone. Full length board allows for adult and little hands to "Express" themselves with easy reach.

Power Post Top

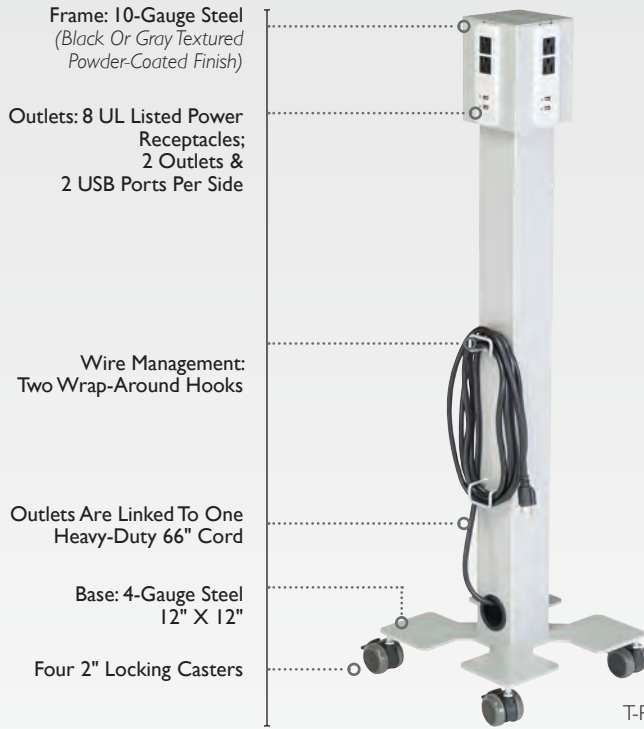

T-PWR-POST - Power Post

Model	Height"	W x D"
Power Post		
T-PWR-POST	38"	12 x 12"

Energize your students with a simple power solution.



Power Ports

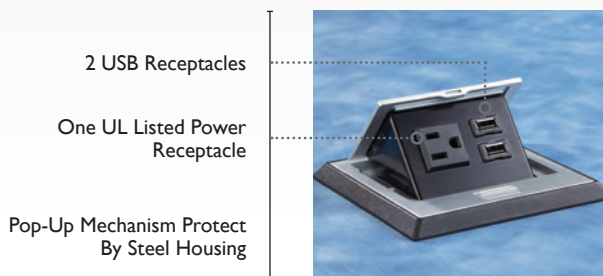

99TT-PWRS-USB - Power Port

Model	W x D"
Power Ports	
99TT-PWRS-2	5 x 5"
99TT-PWRS-USB	5 x 5"

Note: Power Ports must be manufacturer installed.

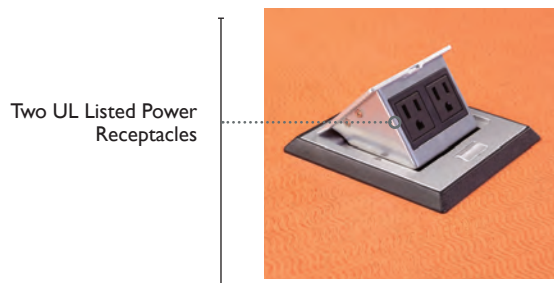

99TT-PWRS-2 - Power Port

Connect: Add a power port to any table or teachers desk and charge any electronic device.

INSTALL SHOWCASE



COLO NESCO JR SR HIGH SCHOOL - COLO, IA



GRETCHKO ELEMENTARY SCHOOL - W BLOOMFIELD TWP, MI



CEDAR MONTESSORI PRESCHOOL - GLENDALE, CA



MEADOWLARK ES - SALT LAKE CITY, UT



KIPP ANTIOCH COLLEGE PREP ELEMENTARY - NASHVILLE, TN



LINCOLN MIDDLE SCHOOL - KANSAS CITY, MO



BERGEN COMMUNITY COLLEGE - PARAMUS, NJ



TRABUCO HILLS HIGH SCHOOL - MISSION VIEJO, CA



STEPHEN F. AUSTIN ELEMENTARY SCHOOL - GRAND PRAIRIE, TX



EAST BROOK ELEMENTARY - PARK RIDGE, NJ



UNIVERSIDAD DE PR EN ARECIBO - ARECIBO, PUERTO RICO



HARDING ELEMENTARY SCHOOL - EL CENTRO, CA



EDISON ELEMENTARY - SALT LAKE CITY, UT



THE PAULA HEDBAVNY SCHOOL PS278 - MANHATTAN, NY



BENJAMIN FRANKLIN CHARTER SCHOOL - FRANKLIN, MA



RIVER BEND MIDDLE SCHOOL - STERLING, VA

Glide Floor Finish Guide

Floor Type	Nylon	Felt	Rubber	Steel
Carpet	•			•
Hardwood		•		
Polished Concrete	•	•		•
Rubber	•		•	
Tile	•	•	•	
Vct(Vinyl)	•	•	•	

Glide Guide

Series	Nylon	Felt	Rubber	Steel
Standard/Inspiration/Hard-Plastic/ Zed/120/400/500/600/700	■	■	■	■
Cantilever Chairs Series 680/Z68	■	■	■	■
Computer Chair Series ¹ 158/458/558/658/Z58	■	■	■	■
Combination Desk Series ² 2200/2500/2900/3200/3500	■	■	■	■
Classic Desk Series 1100/1200/1300/1400/1800	■	■	■	■
V2 Illustration Desk Series 2700	■		■	
Innovation Desk 2000	■	■	■	■
Illustration Table Series	■		■	
T-Leg/C-Leg Series	■		■	
Activity Table Series	■	■	■	■

- STANDARD
- SPECIFY OPTION
- OPTIONAL

¹The options shown are only if stationary bell glides are requested. Standard, the chair ships with casters.
²Excluding Sled Base Combination Desks

Caster Floor Finish Guide

Floor Type	Soft Caster	Hard Caster
Carpet		•
Hardwood	•	
Polished Concrete	•	
Rubber		•
Tile	•	
Vct(Vinyl)		•

Hard casters for soft flooring. Soft casters for hard flooring. See page 113 casters for chairs and tables for visual representation.

Caster Guide

Series	Soft Caster	Hard Caster
128C/518C/618C/718C Chairs	9SF28W-SC	9SF28W-C*
Computer Chair	9HF58SC	9HF58C*
Computer Chair Braking Caster		9HF58LC
Demonstration Series- STEM Table and STEM Work Station		99TW75- Total Lock
Dura, Petal, Synergy, Surge, Harmony, Hercules Legs & V2 Illustration	99TW75-IL-Soft	99TW75-IL-Hard
T-Leg/C-Leg		99TW50M



*Standard caster unless requested otherwise.

Disclaimer: The following information is offered based on our extensive research and testing. This information is recommended as a guide. It is suggested that the customer does their own research to insure that the glide or caster chosen is the proper selection for their flooring.

Desks and Chairs

Series	Glide	Nylon	Felt	Rubber	Steel	Extras
<ul style="list-style-type: none"> • Classic Chair • Inspiration Chair • Zed Chair • Classic Combos • Classic Desk • Activity Tables 	 <p>Glide shown with Felt Cap</p>		 <p>9GL-FLT-CVR</p>	 <p>9GL-TPR-CVR</p>	 <p>9GL-STL-CVR</p>	 <p>Felt Snap Cap 9GL-FELT-SNAP</p>
<ul style="list-style-type: none"> • Swivel Chair • Innovation Desk 	 <p>Glide shown with Felt Insert</p>	 <p>9GL-I-B-NYL 9GL-I-G-NYL</p>	 <p>9GL-I-B-FLT 9GL-I-G-FLT</p>	 <p>9GL-I-B-RUB 9GL-I-G-RUB</p>	 <p>9GL-I-B-STL 9GL-I-G-STL</p>	 <p>Glide Cap Remover</p>
<ul style="list-style-type: none"> • Cantilever Chair 	 <p>Front Glide Back Glide Color-Coordinated Glides shown with Felt Insert</p>	 <p>9GL-I588-NYLSET</p>	 <p>9GL-I588-FLTSET</p>	 <p>9GL-I588-TPRSET</p>	 <p>9GL-I588-STLSET</p>	 <p>Glide Remover for Cantilevered</p> <p>The glide housing and glide inserts have been engineered for easy replacement of worn out inserts. The inserts are designed to mold to flooring and are tamper proof.</p>

Computer Chairs and Tables

Casters				Glides	
 <p>128C/518C/618C/718C Chairs Soft-Caster - 9SF28W-SC Hard-Caster - 9SF28W-C*</p>	 <p>Computer Chair Soft-Caster - 9HF58SC Hard-Caster - 9HF58C*</p>	 <p>Computer Chair Braking Caster 9HF58LC</p>	<p>Note: Please note that casters add 2-3" to the overall height of the item they are being used with. Example, a desk that is 26" without casters, will be 29" with casters. *Standard caster unless requested otherwise.</p>	 <p>Stationary Bell Glides for all computer chairs 9HFSG</p>	
 <p>All Dura, Petal, Synergy, Surge, Harmony, Hercules Legs & V2 Illustration Caster Soft-Caster - 99TW75-IL-Soft Hard-Caster - 99TW75-IL-Hard</p>	 <p>T-Leg/C-Leg Caster 99TW50M</p>	 <p>Demonstration Series-STEM Table and STEM Work Station 99TW75- Total Lock</p>	 <p>Mod® Caster 9Mod-Caster</p>	 <p>Rubber Glide for C-leg/T-leg & all Sled Base Combos 9GL-TPR</p>	 <p>Rubber Glide for Illustration V2 Desks and Tables 9GL-IL-TPR</p>

WOODSTONE & HARD PLASTIC



Woodstone Desktops offer a whole new level of durability, strength, convenience and value.

Woodstone is a mixture of wood fibers and melamine resin, with a laminate finish –baked at 308°F under high pressure.

Lighter: They are 10% lighter than a Hard Plastic Desktop

Affordable: Woodstone Desktops cost about 18% less than conventional hard plastic.

Reliable: Woodstone exceeds ANSI/BIFMA requirement on 5 rigorous tests!



Hard Plastic desktops are solid plastic manufactured with ground hardwood floor, color pigment and melamine plastic resins blended and compressed under heat and pressure to form a homogeneous top.

Classic & Timeless: An all time classic for schools everywhere.

Resilient: Solid Plastic desktops are resilient, heavy-duty and virtually maintenance free.

Designers Portal



Create budgetary pricing according to National KPN contract.



Stay organized by categorizing school and districts into visual project boards.



Download, email or save quotes including specification sheets, cut sheets, product images and CAD drawings.



Chat with Misty McFadden, Academia's Educational Environment Coordinator, for insights on industry trends.



Request our new swatch box and swatch refills.



Request complimentary samples within 48 hours.

www.academiafurniture.com/insights/designers-portal

Designers Portal

Create budgetary contracted pricing and access product specifications, CAD drawings and more with our Designers Portal. If you have any questions on using the portal, feel free to "Ask Misty" below or contact us at 973-472-0100.

Desktop Options



Desk Shapes



Rectangular



Tablet-Arms - Standard & Jumbo Top



Arc-Shaped



Desk Shapes



Rectangular



Tablet-Arms - Standard & Jumbo Top



Innovation



Petal Series



Stimulate and enhance the way students learn by adding color to the classroom. Create an encouraging environment by color coordinating the book boxes, edges and legs to the overall classroom. Look for Educational Edge on the individual item pages to see what can be customized on each of our models.

Educational Edge/Leg Colors



Primary Red Burgundy Purple Primary Blue Navy Ocean Blue



Primary Green Lime Green Tangerine Graphite

Colors shown in this printed catalog may vary slightly from actual product due to aging, lighting, and printing process. For accurate color representations request a complimentary physical swatch.

Woodstone Desktop Colors

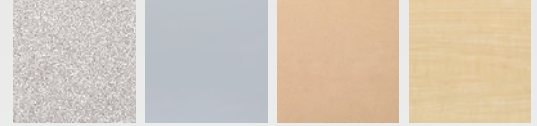

Gray Nebula Light Gray Beige Fusion Maple



Light Oak Cherry Driftwood

Tablet-Arms - Standard & Jumbo Desks: Not available in Fusion Maple and Driftwood.
Arc-Shaped Desks: Not available in Fusion Maple.

Hard-Plastic Desktop Colors

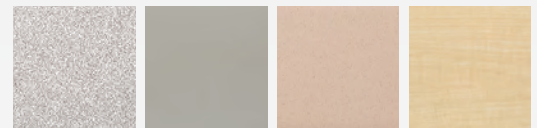

Gray Nebula Light Gray Beige Fusion Maple



Bannister Oak Wild Cherry

Tablet-Arms - Standard & Jumbo Desks: Only available in Light Gray and Beige.
Innovation Series Desks: Not available in Light Gray and Beige.
Petal Series Desks: Not available in Beige.

High-Pressure Laminate Colors



Gray Nebula Fusion Maple Bannister Oak English Oak



Wild Cherry White Board Driftwood

White Board: Warranty and proper care information can be found on our price list or by contacting your local dealer.
White Markerboard is NOT standard for Nate Teacher Desks, Study Carrels, Bookcases, STEM Workstation Cabinet and Tote Bin Cabinet.

Standard Frame Options

Edge Banding & Legs*

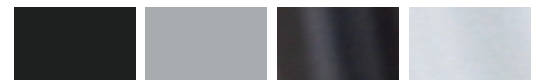

Black Light Gray Black Tungsten Gray

Frame Finishes

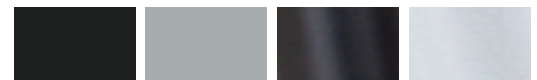

*Only for Tables and Student Desks

Seat Options

Seat Shapes



Squirrel® Stool

Squirrel® Stool Colors



Zed Seats



Inspiration Seats



Classic Seats

Zed, Inspiration & Classic Chair Seat Colors



Hard-Plastic & Round Hard-Plastic Chair Seat Colors



Hard-Plastic Seats



Round Hard-Plastic Seats*

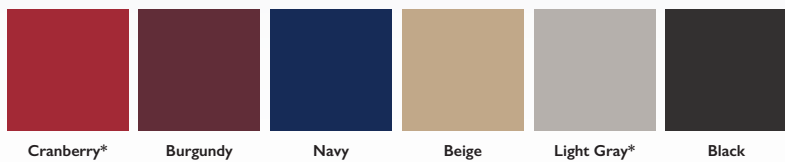

*Note: Cranberry and Light Gray are not available in Round Hard-Plastic Seats

**Request a Complimentary
SWATCH BOX**

Desk, Seat, Table, &
The Mod Series®
Swatches Available



Size Chart

Approximate Chair Size Suggestions

Ht. of Chair Seat	12"	14"	16"	18"	19"
Preschool-K	•	•			
Grade 1		•			
Grade 2		•	•		
Grade 3			•		
Grade 4			•	•	
Grade 5 - 12				•	•

"Squirrel", "The Mod Series" & "Mod" are registered trademarks of Academia Furniture Industries.

Colors shown in this printed catalog may vary slightly from actual product due to aging, lighting, and printing process. For accurate color representations request a complimentary physical swatch.

Accessories

Computer & Seminar Table Accessories



CPU Holder for Hercules, Activity, V2 Illustration, C-Leg, and T-Leg (CPU-ST)



CPU Stand for C-Leg and T-Leg Tables (CPU-T)



CPU Stand for V2 Illustration (CPU-V2)



Wire Management for V2 Illustration (99V2-MP36-72)

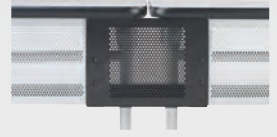

Connector Bridge for V2 Illustration (99IL-MP-Bridge)



Connector Bridge for C-Leg Series Only (99-MP-Bridge)



T-Leg Wire Management (WM36-72)



Wire Management End Cap for Illustration V2 Tables only (99IL-MP-CAP)



Grommets (99GC)



Table Hook for All Except V2 Series (9TAB-HOOK)



Standard Keyboard (Key) 20"W x 11"D



Standard Keyboard with Mouse Pad (KEY-F312) 20"W x 11"D
Mouse is 9" Round



Articulating Key Board (KEY-F178) 28"W x 11"D

Size Chart

Number of Computer Workstations Per Table

Table Width	1 CPU	2 CPUs	3 CPUs
36"	•		
48"	•	•	
60"	•	•	
72"	•	•	•

Desk Accessories



Innovation, Petal, and Surge Series Hooks (9TRI-Hook)



Illustration V2 Backpack Hooks (9DF27-BKHK)



Ganging (9TRI-GANG-4) Only for Innovation



Illustration V2 Modesty Panel (9DF27-MP)



Pencil Drawer for Single & Double Pedestal (99NT-PENCIL)



Cup Holder (99-CUPHOLDER)

Book Boxes



Innovation Mesh Book Box (9TRI-BKBX) 17"W x 12"D x 4"H //3.5WT



Innovation Wire Book Box (9TRI-WBR) 17"W x 14"D x 4"H //2.5 WT



Steel Book Box for T-Leg and Double Desks (99DDMBB-B) 18"W x 16"D x 5"H //5WT



Petal & Jr Petal Mesh Book Box (9DF1950-MBB) 17"W x 12"D x 4"H //3.5WT

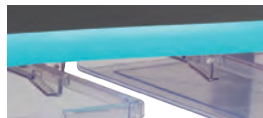

Illustration V2 and Surge Mesh Book Box (9DF17-MBB) 17"W x 12"D x 4½"H //4WT

Tote Bin Cabinet



V2 Desk with Tote Bin



Runner for Desks and Tables

Chairs



Pads (Must be manufacturer installed)



Primary Red



Primary Yellow



Primary Green



Primary Blue



Primary Cool Gray



Pastel Orange



Pastel Green



Pastel Blue



Pastel Lilac



Bold Burgundy Red



Bold Jade Green



Bold Dark Blue



Bold Dark Gray

Colors shown in this printed catalog may vary slightly from actual product due to aging, lighting, and printing process. For accurate color representations request a complimentary physical swatch.

Academia
FURNITURE INDUSTRIES

74 S. Passaic St. Wood-Ridge, NJ 07075
973-472-0100 • academiafurniture.com

